



Board of Administration Agenda

REGULAR MEETING

TUESDAY, NOVEMBER 22, 2022

TIME: 10:00 A.M.

MEETING LOCATION:

In accordance with Government Code Section 54953, subsections (e)(1) and (e)(3), and in light of the State of Emergency proclaimed by the Governor on March 4, 2020 relating to COVID-19 and ongoing concerns that meeting in person would present imminent risks to the health or safety of attendees and/or that the State of Emergency continues to directly impact the ability of members to meet safely in person, the LACERS Board of Administration's November 22, 2022 meeting will be conducted via telephone and/or videoconferencing.

Important Message to the Public

Information to call-in to listen and or participate:

Dial: (669) 254-5252 or (669) 216-1590

Meeting ID# 161 337 9780

Instructions for call-in participants:

- 1- Dial in and enter Meeting ID
- 2- Automatically enter virtual "Waiting Room"
- 3- Automatically enter Meeting
- 4- During Public Comment, **press *9** to raise hand
- 5- Staff will call out the last 3-digits of your phone number to make your comment

Information to listen only: Live Board Meetings can be heard at: (213) 621-CITY (Metro), (818) 904-9450 (Valley), (310) 471-CITY (Westside), and (310) 547-CITY (San Pedro Area).

President: Niza R. Serrano

Vice President: Elizabeth Lee

Commissioners: Annie Chao
Thuy Huynh
Janna Sidley
Sung Won Sohn
Michael R. Wilkinson

Manager-Secretary: Neil M. Guglielmo

Executive Assistant: Ani Ghokassian

Legal Counsel: City Attorney's Office
Public Pensions General
Counsel Division

Notice to Paid Representatives

If you are compensated to monitor, attend, or speak at this meeting, City law may require you to register as a lobbyist and report your activity. See Los Angeles Municipal Code §§ 48.01 *et seq.* More information is available at ethics.lacity.org/lobbying. For assistance, please contact the Ethics Commission at (213) 978-1960 or ethics.commission@lacity.org.

Request for Services

As a covered entity under Title II of the Americans with Disabilities Act, the City of Los Angeles does not discriminate on the basis of disability and, upon request, will provide reasonable accommodation to ensure equal access to its programs, services and activities.

Sign Language Interpreters, Communication Access Real-Time Transcription, Assistive Listening Devices, Telecommunication Relay Services (TRS), or other auxiliary aids and/or services may be provided upon request. To ensure availability, you are advised to make your request at least 72 hours prior to the meeting you wish to attend. Due to difficulties in securing Sign Language Interpreters, five or more business days' notice is strongly recommended. For additional information, please contact: Board of Administration Office at **(213) 855-9348** and/or email at ani.ghokassian@lacers.org.

Disclaimer to Participants

Please be advised that all LACERS Board and Committee Meeting proceedings are audio recorded.

- I. PUBLIC COMMENTS AND GENERAL PUBLIC COMMENTS ON MATTERS WITHIN THE BOARD'S JURISDICTION AND COMMENTS ON ANY SPECIFIC MATTERS ON THE AGENDA – *THIS WILL BE THE ONLY OPPORTUNITY FOR PUBLIC COMMENT - PRESS *9 TO RAISE HAND DURING PUBLIC COMMENT PERIOD*
- II. BOARD PRESIDENT VERBAL REPORT
- III. GENERAL MANAGER VERBAL REPORT
 - A. REPORT ON DEPARTMENT OPERATIONS
 - B. UPCOMING AGENDA ITEMS
- IV. RECEIVE AND FILE ITEMS
 - A. [MONTHLY REPORT ON SEMINARS AND CONFERENCES FOR OCTOBER 2022](#)
- V. COMMITTEE REPORT(S)
 - A. INVESTMENT COMMITTEE VERBAL REPORT FOR THE MEETING ON NOVEMBER 8, 2022
- VI. CONSENT ITEM(S)
 - A. [APPROVAL OF MINUTES FOR THE REGULAR MEETING OF OCTOBER 25, 2022 AND POSSIBLE BOARD ACTION](#)
 - B. [FINDINGS TO CONTINUE TELECONFERENCE MEETINGS AND DETERMINATION THAT COVID-19 STATE OF EMERGENCY CONTINUES TO DIRECTLY IMPACT THE ABILITY OF MEMBERS TO MEET SAFELY IN PERSON AND POSSIBLE BOARD ACTION](#)
- VII. BOARD/DEPARTMENT ADMINISTRATION
 - A. [977 N. BROADWAY PROJECT REPORT FOR THE QUARTER ENDING SEPTEMBER 30, 2022 AND POSSIBLE BOARD ACTION](#)
- VIII. INVESTMENTS
 - A. CHIEF INVESTMENT OFFICER VERBAL REPORT INCLUDING DISCUSSION ON THE PORTFOLIO EXPOSURE TO GLOBAL EVENTS
 - B. [TRANSITION MANAGER FINALIST INTERVIEWS WITH ABEL NOSER, LLC; BLACKROCK INSTITUTIONAL TRUST COMPANY, N.A.; CITIGROUP GLOBAL MARKETS INC.; THE NORTHERN TRUST COMPANY; AND RUSSELL INVESTMENTS IMPLEMENTATION SERVICES, LLC AND POSSIBLE BOARD ACTION](#)

- C. [INVESTMENT MANAGER CONTRACT WITH AXIOM INVESTORS, LLC REGARDING THE MANAGEMENT OF AN ACTIVE NON-U.S. EMERGING MARKETS GROWTH EQUITIES PORTFOLIO AND POSSIBLE BOARD ACTION](#)
- D. [PRESENTATION BY AKSIA CA LLC OF THE PRIVATE EQUITY PROGRAM 2023 STRATEGIC PLAN AND POSSIBLE BOARD ACTION](#)
- E. [NOTIFICATION OF COMMITMENT OF UP TO \\$75 MILLION IN PLATINUM EQUITY CAPITAL PARTNERS VI, L.P.](#)
- F. [NOTIFICATION OF COMMITMENT OF UP TO \\$20 MILLION IN AULDBRASS PARTNERS SECONDARY OPPORTUNITY FUND III, L.P.](#)
- G. [NOTIFICATION OF COMMITMENT OF UP TO €71.0 MILLION \(APPROXIMATELY \\$75.0 MILLION\) IN EIGHTH CINVEN FUND \(NO. 1\) LIMITED PARTNERSHIP](#)
- H. [NOTIFICATION OF COMMITMENT OF UP TO \\$20 MILLION IN SUNSTONE PARTNERS III-MAIN, LP](#)

IX. DISABILITY RETIREMENT APPLICATION(S)

- A. **CLOSED SESSION PURSUANT TO GOVERNMENT CODE SECTION 54957(b) TO CONSIDER THE DISABILITY RETIREMENT APPLICATION OF SHELLIE COOKE AND POSSIBLE BOARD ACTION**

X. OTHER BUSINESS

- XI. NEXT MEETING: The next Regular meeting of the Board is scheduled for Tuesday, December 13, 2022 at 10:00 a.m. at LACERS, 202 West 1st Street, Suite 500, Los Angeles, CA 90012, and/or via telephone and/or videoconferencing. Please continue to view the LACERS website for updated information on public access to Board meetings while response to public health concerns relating to the novel coronavirus continue.

XII. ADJOURNMENT

Agenda of: Nov. 22, 2022

Item No: IV-A

**MONTHLY REPORT ON SEMINARS AND CONFERENCES
ATTENDED BY BOARD MEMBERS ON BEHALF OF LACERS
(FOR THE MONTH OF OCTOBER 2022)**

In accordance with Section V.H.2 of the approved Board Education and Travel Policy, Board Members are required to report to the Board, on a monthly basis at the last Board meeting of each month, seminars and conferences they attended as a LACERS representative or in the capacity of a LACERS Board Member which are either complimentary (no cost involved) or with expenses fully covered by the Board Member. This monthly report shall include all seminars and conferences attended during the 4-week period preceding the Board meeting wherein the report is to be presented.

BOARD MEMBERS:

President Nilza R. Serrano
Vice President Elizabeth Lee

Commissioner Annie Chao
Commissioner Thuy Huynh
Commissioner Janna Sidley
Commissioner Sung Won Sohn
Commissioner Michael R. Wilkinson

DATE(S) OF EVENT	SEMINAR / CONFERENCE TITLE	EVENT SPONSOR (ORGANIZATION)	LOCATION (CITY, STATE)
	NOTHING TO REPORT		

MINUTES OF THE REGULAR MEETING
BOARD OF ADMINISTRATION
LOS ANGELES CITY EMPLOYEES' RETIREMENT SYSTEM

In accordance with Government Code Section 54953, subsections (e)(1) and (e)(3), and in light of the State of Emergency proclaimed by the Governor on March 4, 2020 relating to COVID-19 and ongoing concerns that meeting in person would present imminent risks to the health or safety of attendees and/or that the State of Emergency continues to directly impact the ability of members to meet safely in person, the LACERS Board of Administration's October 25, 2022 meeting will be conducted via telephone and/or videoconferencing.

October 25, 2022

10:00 a.m.

PRESENT via Videoconferencing:	President:	Nilza R. Serrano
	Vice President:	Elizabeth Lee
	Commissioners:	Annie Chao Thuy Huynh Janna Sidley Sung Won Sohn Michael R. Wilkinson
	Legal Counselor:	Anya Freedman
	Manager-Secretary:	Neil M. Guglielmo
	Executive Assistant:	Ani Ghoukassian

The Items in the Minutes are numbered to correspond with the Agenda.

I

PUBLIC COMMENTS AND GENERAL PUBLIC COMMENTS ON MATTERS WITHIN THE BOARD'S JURISDICTION AND COMMENTS ON ANY SPECIFIC MATTERS ON THE AGENDA – *THIS WILL BE THE ONLY OPPORTUNITY FOR PUBLIC COMMENT* – **PRESS *9 TO RAISE HAND DURING PUBLIC COMMENT PERIOD** – President Serrano asked if any persons wanted to make a general public comment to which there was no response.

II

BOARD PRESIDENT VERBAL REPORT – President Serrano stated she is happy with the cooler weather in Los Angeles.

III

GENERAL MANAGER VERBAL REPORT

A. REPORT ON DEPARTMENT OPERATIONS – Neil M. Guglielmo, General Manager, advised the Board of the following items:

- Government Finance Officers Association (GFOA) Financial Reporting Award
- FY24 Budget Process
- Tax Withholding Changes
- Promotion of Ferralyn Sneed to a regular position as Chief Benefits Analyst and Division Manager over Retirement Services Division
- Promotion of Delia Hernandez to a regular position as Senior Benefits Analyst II and Assistant Division Manager of Retirement Services Division
- Promotion of Taneda Larios to Chief Benefits Analyst over new Communications and Stakeholder Relations Division
- Reg IV Non-compliance delays at LACERS HQ
- Parking status at LACERS HQ
- LACERS HQ status updates
- Retirement Services Division update
- Health Benefits Administration updates
- Member Services updates
- Upcoming events

B. UPCOMING AGENDA ITEMS – Neil M. Guglielmo, General Manager, advised the Board of the following items:

- Proposed revisions to Benefits Administration Board Rules are tentatively scheduled for the Benefits Administration Committee in November
- LACERS Staff Parking and Commuter Options Survey Report
- Presentation by Segal Consulting of the Actuarial Valuation as of June 30, 2022 and Proposed City Contribution Rates for FY 2023-24

IV

RECEIVE AND FILE ITEMS

A. MONTHLY REPORT ON SEMINARS AND CONFERENCES FOR SEPTEMBER 2022 – This report was received by the Board and filed.

B. COMMISSIONER LEE BOARD EDUCATION EVALUATION ON INSTITUTIONAL LIMITED PARTNERS ASSOCIATION – PRIVATE EQUITY FOR THE TRUSTEE, SAN FRANCISCO, CA; SEPTEMBER 28-29, 2022 – This report was received by the Board and filed.

C. LEGISLATIVE UPDATE FOR OCTOBER 2022 – Chhintana Kurimoto, Management Analyst, provided the Board with a brief overview of this report. After discussion, this report was received by the Board and filed.

V

COMMITTEE REPORT(S)

- A. INVESTMENT COMMITTEE VERBAL REPORT FOR THE MEETING ON OCTOBER 11, 2022 – Vice President Lee stated the Committee chose and approved the Private Credit Consultant Semi-Finalist and the Securities Lending Program Modifications. The Committee also received and filed the Proxy Voting Activity Report for the period of July 1, 2021 to June 30, 2022 and the Brokerage Activity Report for the period of July 1, 2021 to June 30, 2022.
- B. GOVERNANCE COMMITTEE VERBAL REPORT FOR THE MEETING ON OCTOBER 25, 2022 – Commissioner Sidley stated the Committee approved the Triennial Review of Board Governance and Administrative Policies.

VI

DIVISION SPOTLIGHT

- A. MEMBER SERVICES TEAMS – Taneda Larios, Chief Benefits Analyst, and Tiffany Obembe, Senior Benefits Analyst, presented this item to the Board for 10 minutes.

VII

CONSENT AGENDA

Commissioner Wilkinson moved approval of Consent Agenda Items VII-A and VII-B, seconded by Commissioner Sidley, and adopted by the following vote: Ayes, Commissioners Chao, Huynh, Sidley, Sohn, Wilkinson, Vice President Lee, and President Serrano -7; Nays, None.

- A. APPROVAL OF MINUTES FOR THE REGULAR MEETING OF SEPTEMBER 27, 2022 AND POSSIBLE BOARD ACTION
- B. FINDINGS TO CONTINUE TELECONFERENCE MEETINGS AND DETERMINATION THAT COVID-19 STATE OF EMERGENCY CONTINUES TO DIRECTLY IMPACT THE ABILITY OF MEMBERS TO MEET SAFELY IN PERSON AND POSSIBLE BOARD ACTION

**CONTINUE HOLDING LACERS BOARD AND COMMITTEE MEETINGS
VIA TELECONFERENCE AND/OR VIDEOCONFERENCE**

RESOLUTION 221025-A

WHEREAS, LACERS is committed to preserving public access and participation in meetings of the Board of Administration; and

WHEREAS, all LACERS Board and Committee meetings are open and public, as required by the Ralph M. Brown Act (Cal. Gov. Code 54950 – 54963), so that any member of the public may attend and participate as the LACERS Board and Committees conduct their business; and

WHEREAS, the Brown Act, Government Code Section 54953(e), makes provisions for remote teleconferencing participation in meetings by members of a legislative body, subject to the existence of certain conditions; and

WHEREAS, the COVID-19 State of Emergency proclaimed by the Governor on March 4, 2020 remains active; and

WHEREAS, on October 12, 2021, the Board met via teleconference and determined by majority vote, pursuant to Government Code Section 54953(e)(1)(B)-(C), that due to the COVID-19 State of Emergency, meeting in person would present imminent risks to the health or safety of attendees; and

WHEREAS, the Board has reconsidered the circumstances of the State of Emergency; and

WHEREAS, COVID-19 remains a public health concern in Los Angeles, with substantial community transmission;

NOW THEREFORE, BE IT RESOLVED that pursuant to Government Code Section 54953(e)(1)(B)-(C), the Board finds that holding Board and Committee meetings in person would present imminent risks to the health or safety of attendees.

BE IT FURTHER RESOLVED that pursuant to Government Code Section 54953(e)(3)(A) and (B)(i), the Board finds that the COVID-19 State of Emergency continues to directly impact the ability of Board and Committee members to meet safely in person.

VIII

BOARD/DEPARTMENT ADMINISTRATION

- A. CONTRACT WITH BOX, INC. FOR RETIREMENT APPLICATION PORTAL PHASE TWO AND POSSIBLE BOARD ACTION – Vikram Jadhav, Chief Information Officer, presented and discussed this item with the Board for 10 minutes. After discussion, Vice President Lee moved approval of the following Resolution:

CONTRACT WITH BOX, INC. FOR BOX, INC DESIGN AND DEVELOPMENT SERVICES

RESOLUTION 221025-B

WHEREAS, on December 1, 2021, LACERS executed Contract No. 4245 for consulting services to be performed by Box, Inc. to implement, configure, customize, and integrate the newly released Federal and State tax forms in the Retirement Application Portal (RAP);

WHEREAS, the previous contract focused on making improvements to the RAP's Member-facing components while understanding that backend functionality would be iterated upon in future budget cycles;

WHEREAS, Box, Inc. understands the LACERS' vision for the RAP due to their involvement with its development and is uniquely qualified to continue to build and enhance a system of record within LACERS' Box environment due to the proprietary nature of the Box, Inc. platform;

WHEREAS, it is beneficial for LACERS to continue its partnership with Box, Inc. for the development of the RAP as this tool has produced results that have facilitated the process for LACERS' Members to apply for retirement;

WHEREAS, the Board has appropriated sufficient funds of \$45,000 for necessary enhancements to the RAP related to back-end workflow fixes and integrating updated tax forms for Members; and

WHEREAS, Charter Section 3711(2) and 3711(10) and Los Angeles Administrative Code Section 10.15(a)(2) and (a)(10) provide exemption from the competitive bidding process for contracts where the contracting authority determines that the desired service is of a proprietary nature and where the competitive bidding process would be “undesirable, impractical or impossible.”

NOW, THEREFORE, BE IT RESOLVED, that the Board:

1. Find that, pursuant to City Charter Sections 3711(2) and I(10), and Los Angeles Administrative Code Section 10.15(a)(2) and (a)(10), competitive bidding for the design and continued development of a system of record within Box, Inc. related to enhancements to the Retirement Application Portal would not be desirable, practicable, or advantageous; and
2. Approve an amendment to Contract No. 4245 with Box, Inc. related to the Retirement Application Portal, to extend the term of the contract for one year and to increase the expenditure limit of the contract from \$15,000 to \$45,000; and
3. Authorize the General Manager to negotiate and execute the Contract Amendment, subject to City Attorney approval as to form.

Which motion was seconded by Commissioner Sidley, and adopted by the following vote: Ayes, Commissioners Chao, Huynh, Sidley, Sohn, Wilkinson, Vice President Lee, and President Serrano -7; Nays, None.

IX

INVESTMENTS

- A. CHIEF INVESTMENT OFFICER VERBAL REPORT INCLUDING DISCUSSION ON THE PORTFOLIO EXPOSURE TO GLOBAL EVENTS – Rod June, Chief Investment Officer, reported on the portfolio value of \$20.13 billion as of October 24, 2022. Mr. June discussed the following items:
- LACERS won The Allocator Prize for Idea of the Year; Mr. June recognized Clark Hoover, Investment Officer I, for his work on promoting diversity at LACERS that led to this award.
 - Staff entered LACERS’ ESG Risk Framework and PRI Action Plan into the PRI Awards 2022 competition. PRI notified staff that LACERS did not advance in the competition, but is considering using LACERS’ work as a case study.
 - LACERS Emerging Manager Symposium will be held virtually on November 16, 2022.
 - Future Agenda Items: Aksia Key Person Presentation, PRI Board Member Election, and Transition Manager Recommendations

Mr. June shared that as of October 25, 2022, Russian exposure for LACERS is 2.2 basis points and volatility is still high.

- B. SECURITIES LENDING PROGRAM MODIFICATIONS AND POSSIBLE BOARD ACTION – Bryan Fujita, Investment Officer III, and Jeremiah Paras, Investment Officer I, presented and

discussed this item with Board for 10 minutes. Commissioner Wilkinson moved approval, seconded by Vice President Lee, and adopted by the following vote: Ayes, Commissioners Chao, Huynh, Sidley, Sohn, Wilkinson, Vice President Lee, and President Serrano -7; Nays, None.

- C. CONTRACT WITH AKSIA CA LLC, REPLACEMENT OF KEY PERSON, AND POSSIBLE BOARD ACTION – Clark Hoover, Investment Officer I, presented this item to the Board. Vice President Lee moved approval, seconded by Commissioner Wilkinson, and adopted by the following vote: Ayes, Commissioners Chao, Huynh, Sidley, Sohn, Wilkinson, Vice President Lee, and President Serrano -7; Nays, None.
- D. PRIVATE CREDIT CONSULTANT FINALIST INTERVIEW AND POSSIBLE BOARD ACTION – Wilkin Ly, Investment Officer III, Robert King, Investment Officer II, Trevor Jackson, Managing Director, Mike Krems, Partner, and Tim Nest, Partner, with Aksia, LLC, presented and discussed this item with the Board for 20 minutes. Vice President Lee moved approval of the following Resolution:

**CONTRACT FOR
AKSIA LLC
PRIVATE CREDIT CONSULTING SERVICES**

RESOLUTION 221025-C

WHEREAS, on December 14, 2021, the Board authorized a Request for Proposal for Private Credit Consulting Services; and,

WHEREAS, on June 14, 2022, the Investment Committee approved Aksia LLC, Meketa Investment Group, Inc., and NEPC, LLC as semi-finalist candidates; and,

WHEREAS, staff conducted due diligence on the three semi-finalist candidates; and,

WHEREAS, on October 11, 2022, the Investment Committee interviewed Aksia LLC and Meketa Investment Group, Inc. to understand the capabilities of each firm and subsequently recommended Aksia LLC to the Board for consideration for hire; and,

WHEREAS, on October 25, 2022, the Board approved the Investment Committee’s recommendation for a three-year contract with Aksia LLC.

NOW, THEREFORE, BE IT RESOLVED, that the General Manager is hereby authorized to approve and execute a contract subject to satisfactory business and legal terms and consistent with the following services and terms:

<u>Company Name:</u>	Aksia LLC
<u>Service Provided:</u>	Private Credit Consulting Services
<u>Effective Dates:</u>	November 1, 2022 through October 31, 2025

Duration: Three years

Fee: Year 1 – \$325,000
Year 2 – \$325,000
Year 3 – \$325,000

Which motion was seconded by Commissioner Wilkinson, and adopted by the following vote: Ayes, Commissioners Chao, Huynh, Sidley, Sohn, Wilkinson, Vice President Lee, and President Serrano -7; Nays, None.

E. PRESENTATION BY NEPC, LLC REGARDING INFRASTRUCTURE INVESTMENT OPPORTUNITIES – Carolyn Smith, Partner, and Larissa Davy, Investment Director II, with NEPC, LLC, presented and discussed this item with the Board for 45 minutes.

X

OTHER BUSINESS – There was no other business.

XI

NEXT MEETING: The next Regular meeting of the Board is scheduled for Tuesday, November 8, 2022, at 10:00 a.m. at LACERS, 202 W. 1st Street, Suite 500, Los Angeles, CA 90012, and/or via telephone and/or videoconferencing. Please continue to view the LACERS website for updated information on public access to Board meetings while response to public health concerns relating to the novel coronavirus continue.

XII

ADJOURNMENT – There being no further business before the Board, President Serrano adjourned the Meeting at 12:30 p.m.

Nilza R. Serrano
President

Neil M. Guglielmo
Manager-Secretary



REPORT TO BOARD OF ADMINISTRATION

From: Neil M. Guglielmo, General Manager

Neil M. Guglielmo

MEETING: NOVEMBER 22, 2022

ITEM: VI - B

SUBJECT: FINDINGS TO CONTINUE TELECONFERENCE MEETINGS AND DETERMINATION THAT COVID-19 STATE OF EMERGENCY CONTINUES TO DIRECTLY IMPACT THE ABILITY OF MEMBERS TO MEET SAFELY IN PERSON AND POSSIBLE BOARD ACTION

ACTION: CLOSED: CONSENT: RECEIVE & FILE:

Recommendation

That the Board approve continuing to hold LACERS Board and Committee meetings via teleconference and/or videoconference, under Government Code Sections 54953(e)(1)(B)-(C) and 54953(e)(3)(A) and (B)(i).

Discussion

LACERS is committed to preserving public access and participation in meetings of the Board of Administration. All LACERS Board and Committee meetings are open and public, as required by the Ralph M. Brown Act (Cal. Gov. Code 54950 – 54963), so that any member of the public may attend and participate as the LACERS Board and Committees conduct their business. The Brown Act, Government Code Section 54953(e), makes provisions for remote teleconferencing participation in meetings by members of a legislative body, subject to the existence of certain conditions. The COVID-19 State of Emergency proclaimed by the Governor on March 4, 2020 remains active: COVID-19 remains a public health concern in Los Angeles, with substantial community transmission.

The Board met via teleconference on October 12, 2021, and determined by majority vote, pursuant to Government Code Section 54953(e)(1)(B)-(C), that due to the COVID-19 State of Emergency, meeting in person would present imminent risks to the health or safety of attendees.

Strategic Plan Impact Statement

The Board's action on this item aligns with the LACERS Strategic Plan Goal to uphold good governance practices which affirm transparency, accountability, and fiduciary duty.

Prepared By: Ani Ghoukassian, Commission Executive Assistant II

Attachment: Proposed Resolution

CONTINUE HOLDING LACERS BOARD AND COMMITTEE MEETINGS
VIA TELECONFERENCE AND/OR VIDEOCONFERENCE

PROPOSED RESOLUTION

WHEREAS, LACERS is committed to preserving public access and participation in meetings of the Board of Administration; and

WHEREAS, all LACERS Board and Committee meetings are open and public, as required by the Ralph M. Brown Act (Cal. Gov. Code 54950 – 54963), so that any member of the public may attend and participate as the LACERS Board and Committees conduct their business; and

WHEREAS, the Brown Act, Government Code Section 54953(e), makes provisions for remote teleconferencing participation in meetings by members of a legislative body, subject to the existence of certain conditions; and

WHEREAS, the COVID-19 State of Emergency proclaimed by the Governor on March 4, 2020 remains active; and

WHEREAS, on October 12, 2021, the Board met via teleconference and determined by majority vote, pursuant to Government Code Section 54953(e)(1)(B)-(C), that due to the COVID-19 State of Emergency, meeting in person would present imminent risks to the health or safety of attendees; and

WHEREAS, the Board has reconsidered the circumstances of the State of Emergency; and

WHEREAS, COVID-19 remains a public health concern in Los Angeles, with substantial community transmission;

NOW THEREFORE, BE IT RESOLVED that pursuant to Government Code Section 54953(e)(1)(B)-(C), the Board finds that holding Board and Committee meetings in person would present imminent risks to the health or safety of attendees.

BE IT FURTHER RESOLVED that pursuant to Government Code Section 54953(e)(3)(A) and (B)(i), the Board finds that the COVID-19 State of Emergency continues to directly impact the ability of Board and Committee members to meet safely in person.



REPORT TO BOARD OF ADMINISTRATION

From: Neil M. Guglielmo, General Manager

Neil M. Guglielmo

MEETING: NOVEMBER 22, 2022

ITEM: VII-A

SUBJECT: 977 N. BROADWAY PROJECT REPORT FOR THE QUARTER ENDING SEPTEMBER 30, 2022 AND POSSIBLE BOARD ACTION

ACTION: CLOSED: CONSENT: RECEIVE & FILE:

Recommendation

That the Board receive and file this update report on the 977 N. Broadway Project and the attached presentation.

Executive Summary

Presented to the LACERS Board of Administration ("Board") is the 977 N. Broadway Project Report for the Quarter Ending September 30, 2022. This is the first quarterly report issued since the Board approved the Fiscal Year 2022-23 Capital Budget and Operating Expense Budget for LACERS' new Headquarters Building on May 24, 2022.

Discussion

The attached report provides detailed updates on the progress and status of the 977 N. Broadway Project.

Strategic Plan Impact Statement

Ownership in 977 North Broadway advances the Board Governance Goal and Organization Goal by being a cost-effective investment in the long-term as compared to leasing and provides LACERS with complete control over its administrative facilities adding to the organization's efficiency, effectiveness, and resiliency.

Prepared By: Isaias Cantú, Chief Management Analyst

NMG/TB:ic

Attachments: 1. 977 N. Broadway Project Report for the Quarter Ending September 30, 2022



BOARD Meeting: 11/22/22
Item VII-A
Attachment 1

977 N. BROADWAY PROJECT REPORT FOR QUARTER ENDING SEPTEMBER 30, 2022

For Los Angeles City Employees' Retirement System



TABLE OF CONTENTS

- Executive Summary
- Capital Project Summary
- Project Timeline
- Financial Overview



EXECUTIVE SUMMARY

The Headquarters Move Project completed design scopes, completed building enclosure work, largely completed the tenant improvement work, and has begun the information technology migration work and furniture installation.

Project Timeline

- ❖ Working through the permitting processes and supply chain issues have been the primary drivers of the extended construction schedule and move-in delays.
- ❖ Tenant Improvement work and furniture installation will be completed by December 12, 2022.
- ❖ LACERS occupancy of the building is still projected for December 22, 2022.

Budget

- ❖ LACERS has spent 85.42% of the capital budget for the 977 N. Broadway Project.
- ❖ Ongoing efforts to mitigate the effects of supply-chain disruption on budget and project schedule.

Completed Milestones

- ❖ Façade/Enclosure/Abatement construction work has been completed.
- ❖ Seismic strengthening construction work has been completed.
- ❖ Furniture/finishes selections have been delivered.
- ❖ Server Room construction has been completed and turned over to LACERS' Systems team for network setup.
- ❖ FitWel Two-Star Certification application submitted and under review.
- ❖ Carpet installation has been completed on Floors 2-5.



CAPITAL PROJECT SUMMARY



Cost Control

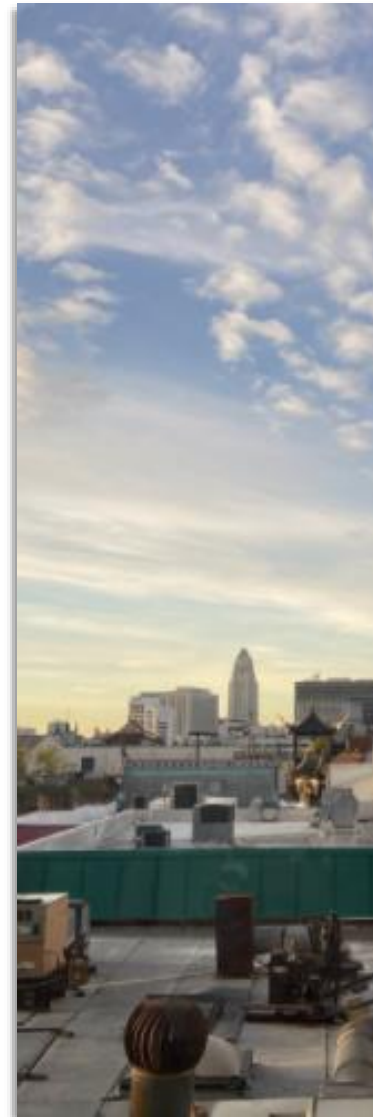
- ❖ Realign project priorities to stay within the approved budget.
- ❖ Regular communications with contractors, vendors, manufacturers, and suppliers to prepare and mitigate supply-chain disruptions and cost increases.
- ❖ Change orders due to permitting and lead time delays in the project, modifications required after the tenant improvement work, and scope changes were reviewed to ensure the expense was justified and tracked.

Pre-Construction

- ❖ Internal demolition has been completed.
- ❖ Pre-construction for make-ready work was completed.
- ❖ Design work on security and gate infrastructure was submitted and approved by LADBS.
- ❖ Electrical work package was approved, issued, and work contracted.
- ❖ Pre-construction estimates completed for tenant improvement, low-voltage, and furniture.
- ❖ FitWel certification gap analysis performed and consultant contracted.

Permitting

- ❖ Permit applications approved by LADBS
 - 1st Floor Assembly Area
 - 2nd Floor Package
 - 1st Fl partial, 3rd, 4th, 5th Floor Package
 - Diesel Generator
 - Electrical
 - Fall Arrest Anchorage
 - ❖ SCAQMD Permit to operate new backup diesel generator - Approved
- | |
|---------------------------------------|
| HVAC |
| Mechanical |
| Plumbing |
| Security Gate/Fence |
| Structural work for Nat Gas Generator |



CAPITAL PROJECT SUMMARY

Construction Achievements

- ❖ Seismic reinforcement work has been completed.
- ❖ Façade/Enclosure/Abatement work has been completed.
- ❖ Roof replacement work has been completed.
- ❖ Parking Garage paint/restriping vendor has been contracted.
- ❖ New diesel generator has been placed on the roof along with a 50-gallon tank. A fuel filling station has been installed on the ground floor that will pump diesel up to the 50-gallon tank on the roof. The final installation of fuel lines is complete.
- ❖ Tenant Improvement work is underway and expected to be completed in Q2 of FY23.
- ❖ Furniture delivery and installation is underway on Floors 2-5.

Technology Milestones

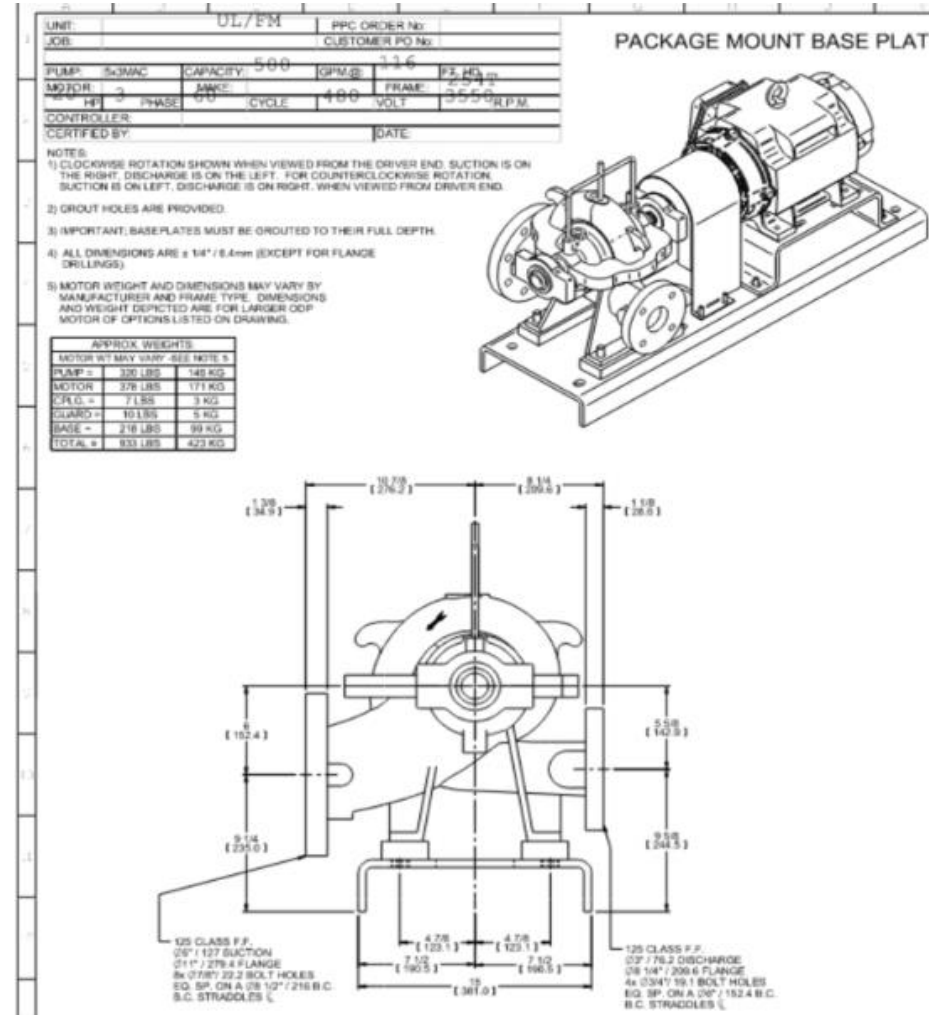
- ❖ **Security Equipment Installed** – Pinnacle Solutions, the technology consultant for the project, has installed all security cameras and are in the configuration phase. Panic button installation and configuration are being coordinated with ITA, the Pinnacle Security team, and Verkada who manufactures the necessary hardware.
- ❖ **AV Equipment Installation** – Pinnacle has begun installing Audio/Video equipment throughout the floors. Installation includes conference room monitors, video conferencing equipment, microphones, paging speakers, and mass communication equipment.
- ❖ **Information Technology Migration** – The 977-server room has been officially turned over to LACERS Systems team. Systems has completed an initial migration of equipment from the LA Times to 977.
- ❖ **Network Equipment Procurement** – The new headquarters is being equipped with the latest, best-of-breed, network appliances inclusive of routers, firewalls, switches, wireless access points, and security devices. Completion is expected in Q2 of FY23.



CAPITAL PROJECT SUMMARY

Fire Pump Inspection Delays

- ❖ LACERS has been working with LAFD to address a Notice of Violations for Reg IV Non-compliance.
- ❖ LADBS has requested additional corrections to the fire pump electrical design which delays the FLS testing that LAFD requires in order to allow LACERS to occupy the building.
- ❖ LACERS continues to work closely with both LAFD and LADBS to address concerns surrounding the jockey pump replacement and its electrical components.
- ❖ ARC Engineering, the General Contractor, and Electrical subcontractors have been tapped to design solutions to address LADBS' concerns as well as source and price the necessary electrical components. Unfortunately, supply-chain constraints could continue to impact the lead times for any necessary specialized components.



Supply-Chain Disruption

- ❖ Supply-chain disruptions are creating a strain on the project and volatile price increases from all vendor and supply companies.
- ❖ LACERS is working with partners to mitigate these impacts on budget and supply lead times by exploring temporary equipment, alternate supplies, prioritizing the early release of bids for material with long lead times, reaching out to suppliers, and adjusting the construction sequencing.
- ❖ Supply-chain and permitting delays required a minimum of six-month contract extensions for several project consultants which had not been budgeted and have been paid out of contingency funds.
- ❖ Lead times have recently had an impact on LACERS' repairs to the FLS System fire pump and jockey pump to comply with Reg IV regulations.
- ❖ Pinnacle Communications has reported lead time delays on card readers which were supposed to be delivered this quarter and projected to be delayed until next year. An alternate supplier is being contacted to source this equipment prior to our December 22, 2022 move-in.



CAPITAL PROJECT SUMMARY

The entire roof has been replaced with a new roof with a 30-year warranty. The roof now houses a new diesel generator that replaced the building's old gas-powered generator.



August 2021



July 2022



September 2022

CAPITAL PROJECT SUMMARY

Significant progress has been made in the interior of the building since the early construction phase. In this quarter alone, the progress on Floors 2-5 continues to transform the space with the early addition of furniture and carpeting.



August 2021

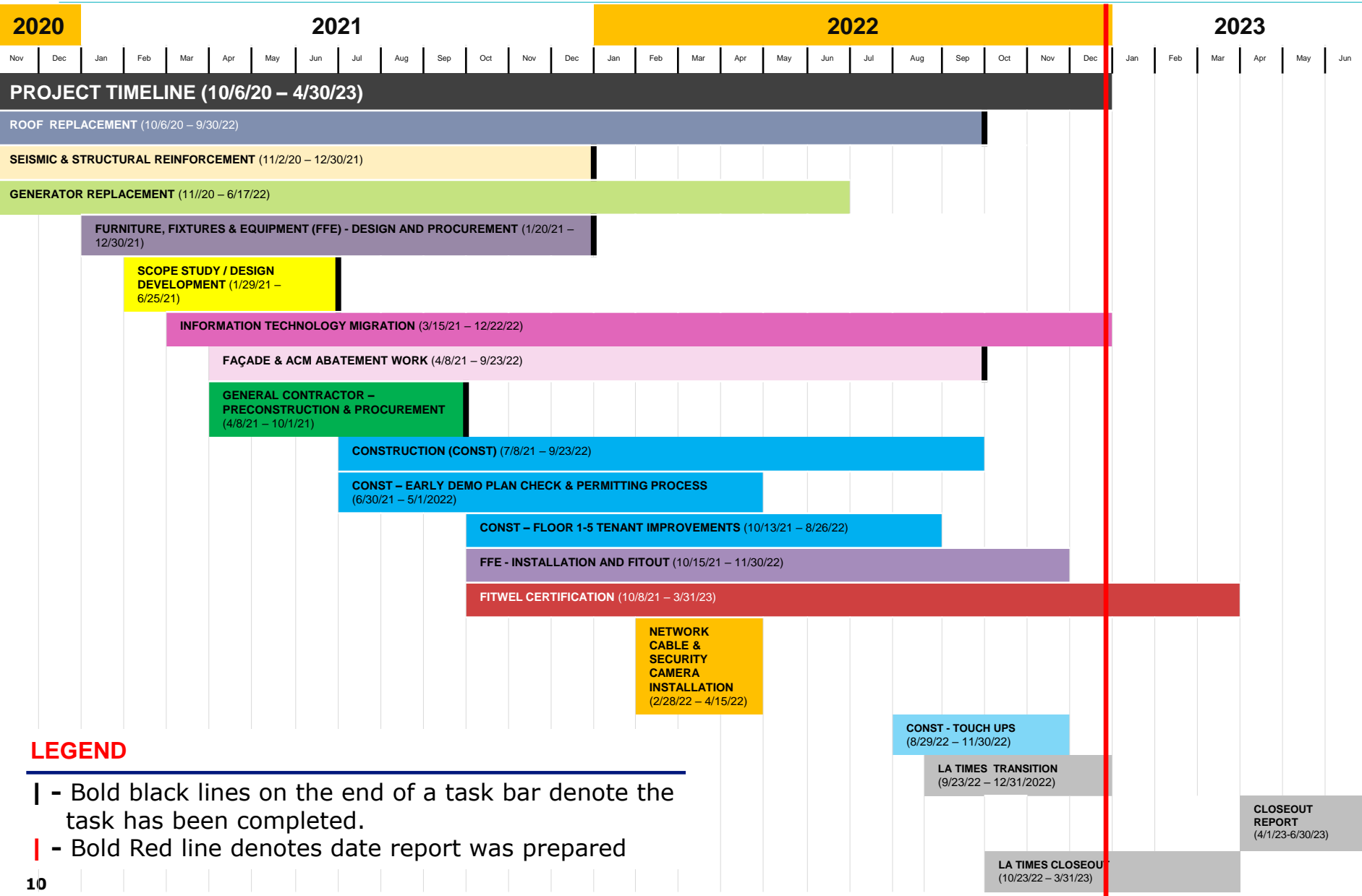


July 2022



September 2022

PROJECT TIMELINE



LEGEND

- Bold black lines on the end of a task bar denote the task has been completed.
- Bold Red line denotes date report was prepared

FINANCIAL OVERVIEW



FY 2022/23 Q1 Financial Status Report (July 2022 – September 2022)

Budget	Budgeted Amount	Actuals FYTD	% Budgeted Amount Expended FYTD	Budget Variance Comments
Operating	\$1,543,200	\$288,152	18.67%	
Capital	\$19,878,381	\$17,066,202	85.42%	
Capital Contingency	\$100,000	-	-	Board Approved additional contingency funds on September 27.
Total	\$21,521,581	\$17,354,354	80.64%	

NOTE: The data presented in this chart reflect expenses paid out through the Property Management Account.

977 N BROADWAY



LOS ANGELES CITY EMPLOYEES' RETIREMENT SYSTEM

202 W. FIRST STREET, SUITE 500
LOS ANGELES, CA 90012
(800) 779-8328 / RTT: (888) 349-3996
LACERS.ORG





REPORT TO BOARD OF ADMINISTRATION

From: Investment Committee
Elizabeth Lee, Chair
Nilza R. Serrano
Janna Sidley

MEETING: NOVEMBER 22, 2022
ITEM: VIII - B

SUBJECT: TRANSITION MANAGER FINALIST INTERVIEWS WITH ABEL NOSER, LLC; BLACKROCK INSTITUTIONAL TRUST COMPANY, N.A.; CITIGROUP GLOBAL MARKETS INC.; THE NORTHERN TRUST COMPANY; AND RUSSELL INVESTMENTS IMPLEMENTATION SERVICES, LLC AND POSSIBLE BOARD ACTION

ACTION: CLOSED: CONSENT: RECEIVE & FILE:

Recommendation

That the Board:

1. Award contracts for five-year terms to the following five firms for transition management services: Abel Noser, LLC; BlackRock Institutional Trust Company, N.A.; Citigroup Global Markets Inc.; The Northern Trust Company; and Russell Investments Implementation Services, LLC; and
2. Authorize the General Manager to approve and execute the necessary documents, subject to satisfactory business and legal terms.

Executive Summary

On November 3, 2022, the Committee interviewed and approved five firms to proceed as finalists for the Investment Transition Management Services search: Abel Noser, LLC; BlackRock Institutional Trust Company, N.A.; Citigroup Global Markets Inc.; The Northern Trust Company; and Russell Investments Implementation Services, LLC. The Committee recommends that the Board award five-year contracts to all five firms to comprise LACERS' new bench of transition management service providers.

Discussion

The Board approved a request for proposal (RFP) process to evaluate the current marketplace for Transition Management Services on January 25, 2022. LACERS is seeking to refresh the existing

bench of transition management service providers with up to five firms to manage LACERS' portfolio restructuring needs. The search opened on February 14, 2022, and closed on April 11, 2022. A total of eight proposals were received; no proposals were received from emerging investment manager firms. On July 12, 2022, the Committee considered staff's evaluation of the proposals and advanced five firms to proceed as semi-finalists for staff to conduct further due diligence on:

- Abel Noser, LLC (incumbent firm)
- BlackRock Institutional Trust Company, N.A. (incumbent firm)
- Citigroup Global Markets Inc. (incumbent firm)
- The Northern Trust Company
- Russell Investments Implementation Services, LLC

Due Diligence

Staff's due diligence consisted of on-site meetings at the semi-finalists' offices, teleconferences, and reference checks. Specific areas of examination included the firm's personnel, trading, technology, compliance, business continuity, and historical performance on transition management projects. Based on the due diligence, staff deemed all five semi-finalists to be qualified to provide the requested services to LACERS and recommended that the Committee interview and advance all five firms as finalists in the search.

Committee Recommendation

On November 3, 2022, the Committee interviewed the five semi-finalists and inquired about each firm's capabilities to execute transition management services for LACERS. Following the interviews and discussion with staff, the Committee concurred with staff's recommendation to advance all five firms to the Board for consideration of five-year contract awards. If hired by the Board, this diversified group of firms would comprise LACERS' new bench of transition management service providers and provide LACERS with a broad range of transition management capabilities across multiple asset classes.

Representatives of the finalist firms will be present at the November 22, 2022, Board meeting should the Board desire to hear brief introductions from each firm.

Strategic Plan Impact Statement

The RFP for investment transition management services to create a bench of transition managers assists the fund with optimizing long-term risk adjusted investment returns (Goal IV). Implementing a competitive bidding process by issuing an RFP is in line with Goal V (uphold good governance practices which affirm transparency, accountability, and fiduciary duty).

Prepared By: James Wang, Investment Officer I, Investment Division

NMG/RJ/BF/JW:rm

Attachments: 1. Report to Investment Committee Dated November 3, 2022
2. Proposed Resolutions



LACERS
LA CITY EMPLOYEES'
RETIREMENT SYSTEM



REPORT TO INVESTMENT COMMITTEE
From: Neil M. Guglielmo, General Manager

MEETING: NOVEMBER 3, 2022
ITEM: II

SUBJECT: TRANSITION MANAGER SEMI-FINALIST INTERVIEWS WITH ABEL NOSER, LLC; BLACKROCK INSTITUTIONAL TRUST COMPANY, N.A.; CITIGROUP GLOBAL MARKETS INC.; THE NORTHERN TRUST COMPANY; AND RUSSELL INVESTMENTS IMPLEMENTATION SERVICES, LLC AND POSSIBLE COMMITTEE ACTION

ACTION: **CLOSED:** **CONSENT:** **RECEIVE & FILE:**

Recommendation

That the Committee:

1. Interview the following five firms as the qualified semi-finalists in the Investment Transition Management Services search: Abel Noser, LLC; BlackRock Institutional Trust Company, N.A.; Citigroup Global Markets Inc.; The Northern Trust Company; and Russell Investments Implementation Services, LLC; and
2. Advance all five firms as finalists for contract awards by the Board.

Executive Summary

On July 12, 2022, the Committee approved five firms to proceed as semi-finalists for the Investment Transition Management Services search: Abel Noser, LLC; BlackRock Institutional Trust Company, N.A.; Citigroup Global Markets Inc.; The Northern Trust Company; and Russell Investments Implementation Services, LLC. Based on due diligence conducted on each firm, staff recommends that the Committee interview each firm and advance all five firms to the Board for contract awards to comprise LACERS' new bench of transition management service providers.

Background

The Board approved a request for proposal (RFP) process to evaluate the current marketplace for Transition Management Services on January 25, 2022. LACERS is seeking to refresh the existing bench of transition management service providers with up to five firms to manage LACERS' portfolio restructuring needs.

The search opened on February 14, 2022, and closed on April 11, 2022. A total of eight proposals were received; no proposals were received from emerging investment manager firms. On July 12, 2022, the

Committee considered staff's evaluation of the proposals and advanced five firms to proceed as semi-finalists for staff to conduct further due diligence on:

- Abel Noser, LLC (incumbent firm)
- BlackRock Institutional Trust Company, N.A. (incumbent firm)
- Citigroup Global Markets Inc. (incumbent firm)
- The Northern Trust Company
- Russell Investments Implementation Services, LLC

Due Diligence

Staff's due diligence consisted of on-site meetings at the semi-finalists' offices, teleconferences, and reference checks. Specific areas of examination included the firm's personnel, trading, technology, compliance, business continuity, and historical performance on transition management projects. Staff's due diligence confirmed the capabilities of each firm as described in the proposals and yielded no material adverse findings. Accordingly, staff deems all five semi-finalists to be qualified to provide transition management services to LACERS. Staff recommends all five firms to proceed as finalists to comprise LACERS' new bench of transition management service providers. This diversified group of managers will provide LACERS with a broad range of transition management capabilities across multiple asset classes.

Upon Investment Committee interview and concurrence with the staff recommendation, the proposed finalists will be moved forward to the Board for consideration and contract awards. The Board will be provided the opportunity to meet and interview the finalists, if desired, consistent with the process approved by the Board on January 25, 2022.

Strategic Plan Impact Statement

The RFP for investment transition management services to create a bench of transition managers assists the fund with optimizing long-term risk adjusted investment returns (Goal IV). Implementing a competitive bidding process by issuing an RFP is in line with Goal V (uphold good governance practices which affirm transparency, accountability, and fiduciary duty).

Prepared By: James Wang, Investment Officer I, Investment Division

NMG/RJ/BF/JW/JP:rm

- Attachments:
1. Transition Manager Semi-Finalist Matrix
 2. Semi-Finalist Presentation – Abel Noser, LLC
 3. Semi-Finalist Presentation – BlackRock Institutional Trust Company, N.A.
 4. Semi-Finalist Presentation – CitiGroup Global Markets Inc.
 5. Semi-Finalist Presentation – The Northern Trust Company
 6. Semi-Finalist Presentation – Russell Investments Implementation Services, LLC

2022 Investment Transition Management Services Search Semi-Finalist Matrix					
Firm legal name	Abel Noser, LLC	BlackRock Institutional Trust Company, N.A.	Citigroup Global Markets Inc.	The Northern Trust Company	Russell Investments Implementation Services, LLC
Location of primary office servicing the LACERS account	New York, NY	San Francisco, CA	New York, NY	Chicago, IL	Seattle, WA
Firm ownership structure	Wholly owned by Abel Noser Holdings, which in turn is majority owned by Estancia Capital and minority owned by Abel Noser employees.	Publicly traded investment company (NYSE: BLK).	Wholly owned, through a chain of subsidiaries, by Citigroup Inc., a publicly traded financial services company (NYSE: C).	Wholly owned subsidiary of Northern Trust Corporation, a publicly traded financial services company (NASDAQ: NTRS).	Majority owned by private equity funds managed by TA Associates.
Year firm began providing transition management	1986	1993	1996	1988	1980
Number of years of firm experience in transition management	36	29	26	34	40
Number of transition management and support staff	47	60	220	91	21
Primary contact for transition projects	Michael Iannucci, Managing Director/Head of Transition Management	John Planek, Vice President	Jerome Hogan, Vice President	Chris Honold, Vice President – Transition Management	Travis Bagley, Director – Transition Management



Transition Management

Presented to:

LACERS Investment Committee

November 3rd, 2022

PETER WEILER / Co-CEO / pweiler@abelnoser.com

DORIS PRADIEU / SVP, Transition Management / dpradieu@abelnoser.com

KEVIN YU / SVP, Transition Management / kyu@abelnoser.com

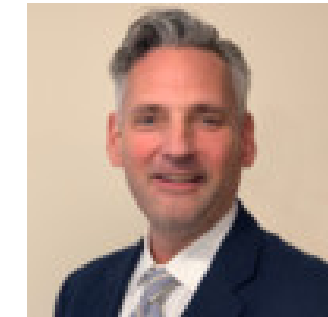
MARY DAVIDSON / SVP, Client Services / mdavidson@abelnoser.com

MICHAEL IANNUCCI / Head of Transition Management / miannucci@abelnoser.com

Presenters

Peter Weiler

- As **Co-CEO** of **Abel Noser Holdings**, Peter leads the firm's TCA and brokerage efforts. Over the years, he has provided consultative services to many of the world's leading institutional investors. Peter has also served as an adjunct professor at GW University. Peter holds a B.A. from Villanova University.



Doris Pradiou

- A **Senior VP** with our **TM Team**, Doris joined in 2009, having spent the previous five years with BNY's TM group. Doris is responsible for the development of Abel Noser's fixed income transition platform. She has an MBA in International Finance from Hofstra University



Kevin Yu

- Kevin is a **Senior VP** with the **TM Team**, and serves as a project coordinator and analyst for equity mandates. Kevin has been with the team since 2013, and has prior experience in the custody space. Kevin has a M.S. in Finance from Villanova University.



Mary Davidson

- Mary is a **Senior VP** with our **Client Services Team**, with responsibility for asset owners and consultants through much of the US. Mary has been with Abel Noser since 1995, and has a B.A. from Tulane University.



Michael Iannucci

- Michael is **Managing Director** and Head of the **TM Team** at Abel, and has been with the firm since 2004. He is a graduate of the College of William and Mary with concentrations in Economics and English, and is a frequent speaker at industry conferences.





Abel Noser

Over 30 Years of Industry Leading Analytics and Agency Trading

Founded in 1975 by Stanley S. Abel and Eugene A. Noser, Jr., Abel Noser is a registered agency-only broker-dealer and RIA. **Abel Noser** has long been respected as a leader in the campaign to lower the costs of trading for institutional investors. Each of our main business activities - global transition management services, transaction cost analysis, and agency-only institutional trading services – seeks to deliver efficiency and transparency to the investment process. **Abel Noser** is a global company with offices in New York, London, Metro DC, Atlanta and Los Angeles.

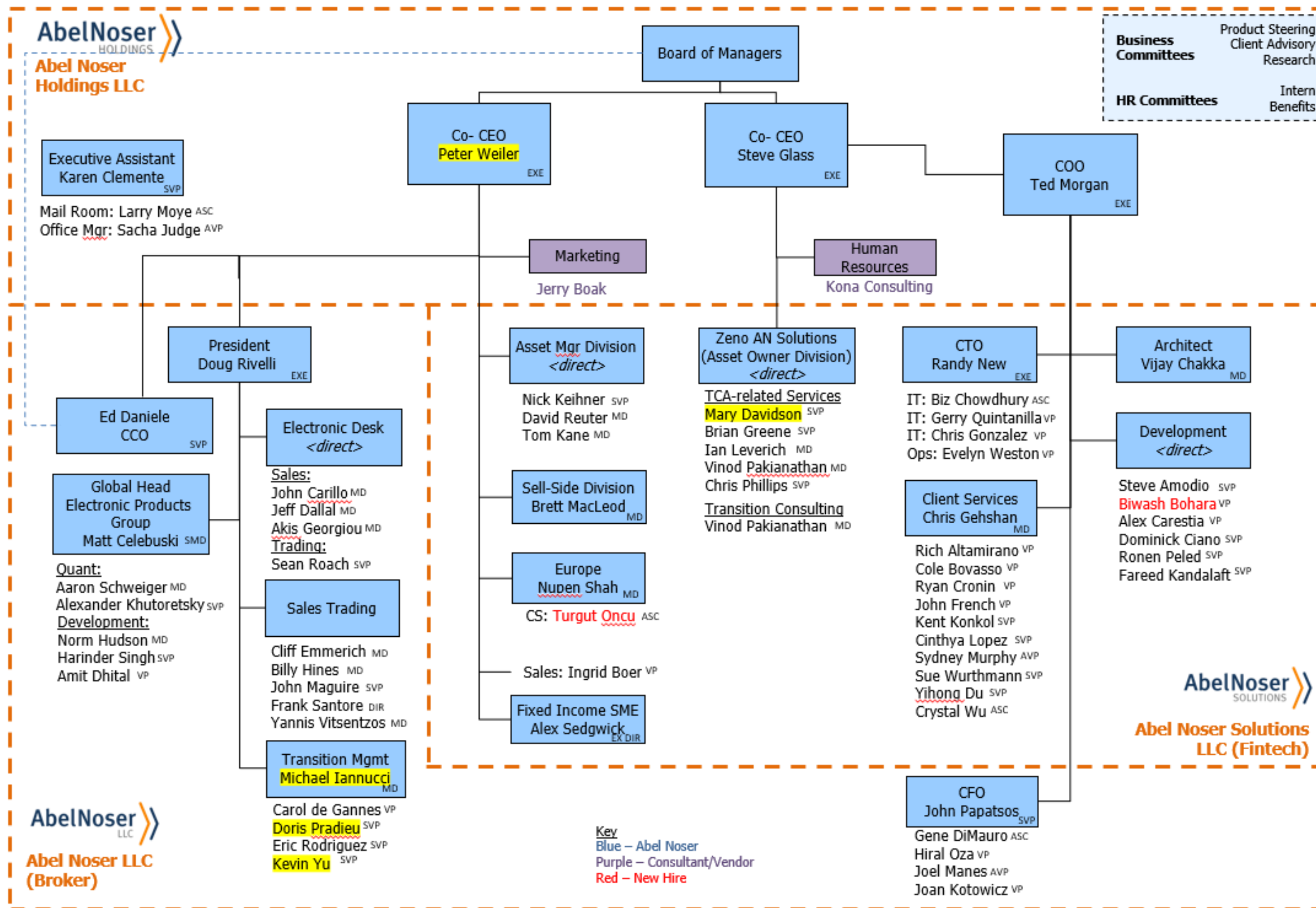
Transition Management Services

Experience and Analytics Make the Difference

As an industry leading provider of Transaction Cost Analysis, **Abel Noser** has a long history of working with asset owners to lower the costs associated with implementing their investment decisions. Transition management is a natural extension of this mission. We have built our trading environment from the ground up with one goal in mind: to consistently deliver measurably better executions. The coordination of experience and technology is fundamental to our ability to achieve optimal transition results. We emphasize communication during all phases of the process, understanding its importance in achieving your goals.

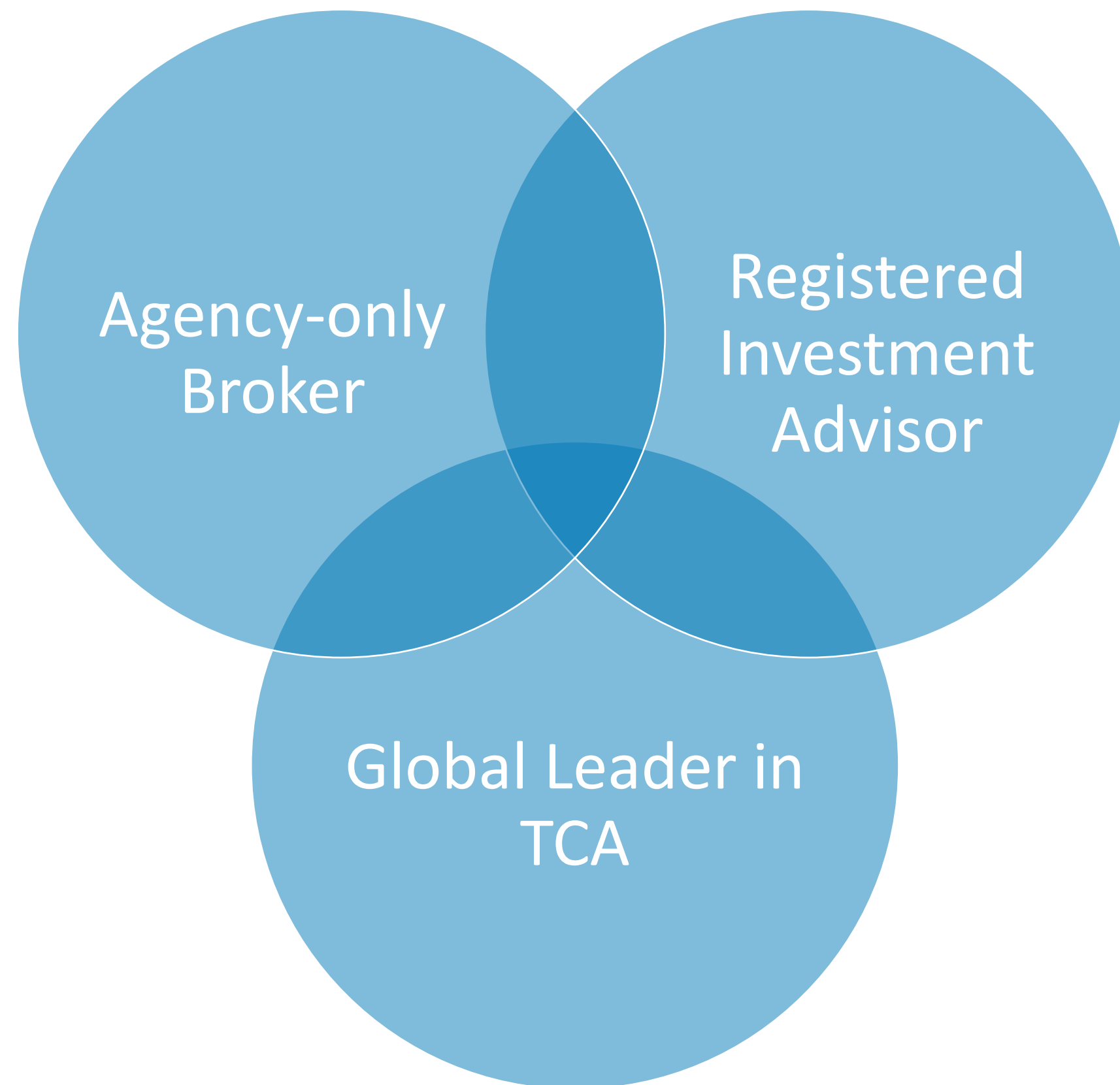


Organizational Chart



Transition Management Overview

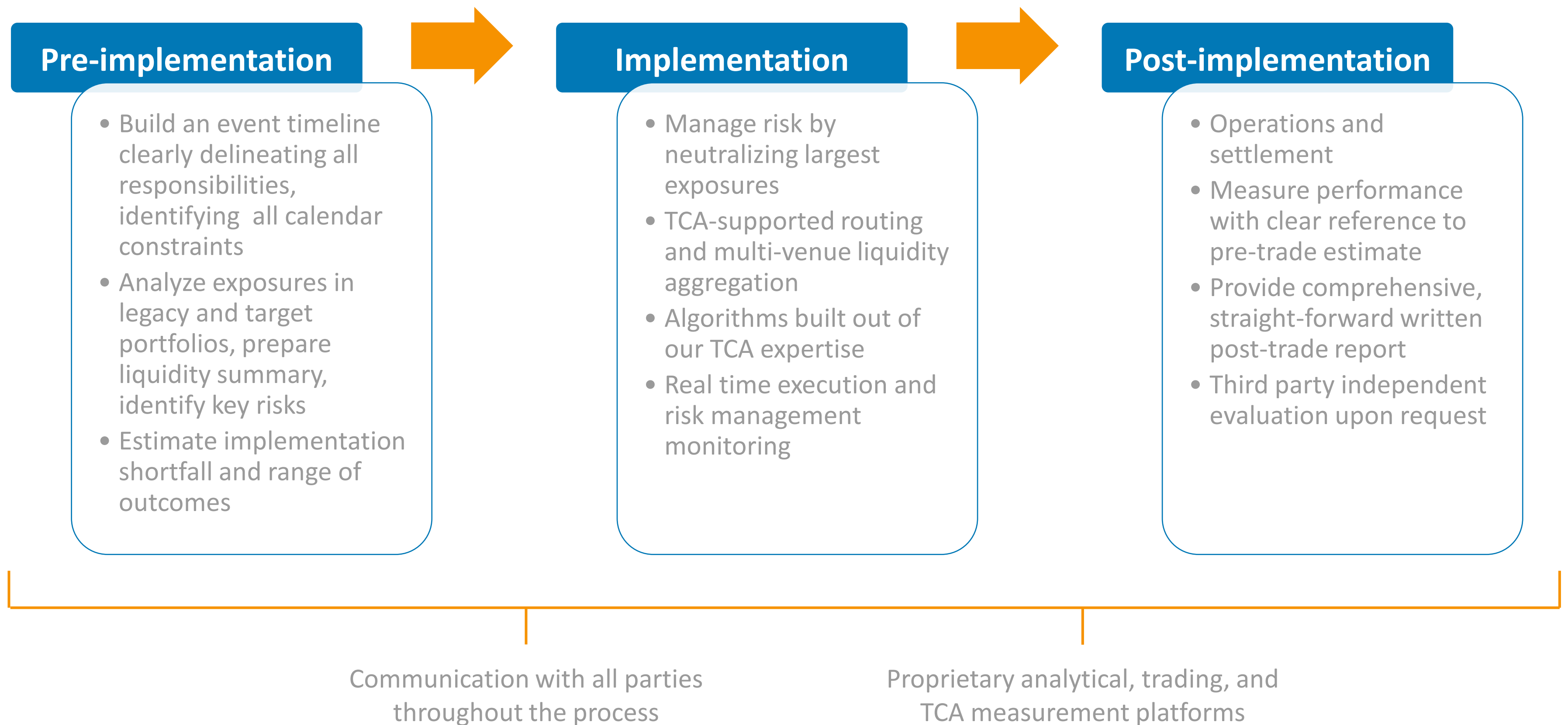
Abel Noser has been a provider of comprehensive Transition Management services since 1986. Our dedicated team operates out of Abel Noser, L.L.C., a duly registered broker dealer and registered investment advisor.



- As an **agency-only broker**, our sole objective is to act on our client's behalf in the market. We do not maintain any proprietary accounts, nor do we have an affiliated asset management arm against which TM orders may compete. And importantly, we do not maintain a commercial interest in any pools of liquidity.
- As a **Registered Investment Advisor**, we serve in a fiduciary capacity for nearly all of our TM mandates. The RIA designation also affords us access to best of breed technologies, as well as liquidity sources which restrict access to the buy-side.
- **Transaction Cost Analysis** informs every phase of Abel Noser's transition process. Our array of proprietary pre, intra, and post-trade tools are leveraged to the client's benefit in the TM setting, and our \$11 trillion universe of measured trades provides empirical support for everything we do, from how we route, to how we interact with each liquidity destination, to which algorithms we use.

Transition Management – Step by Step

Transaction Cost Analysis (TCA) informs every phase of Abel Noser’s transition process

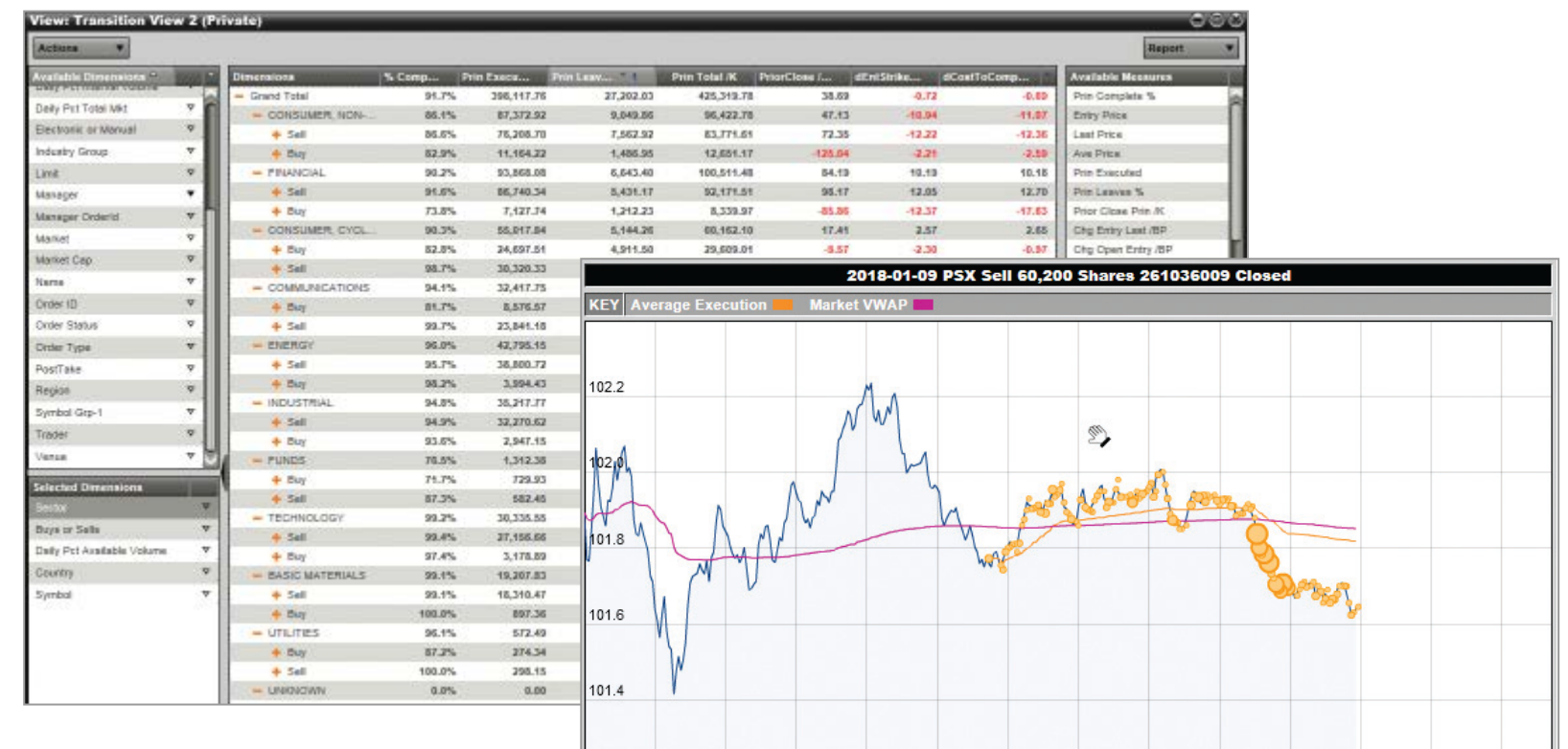


TCA-Driven Agency-Only Trading

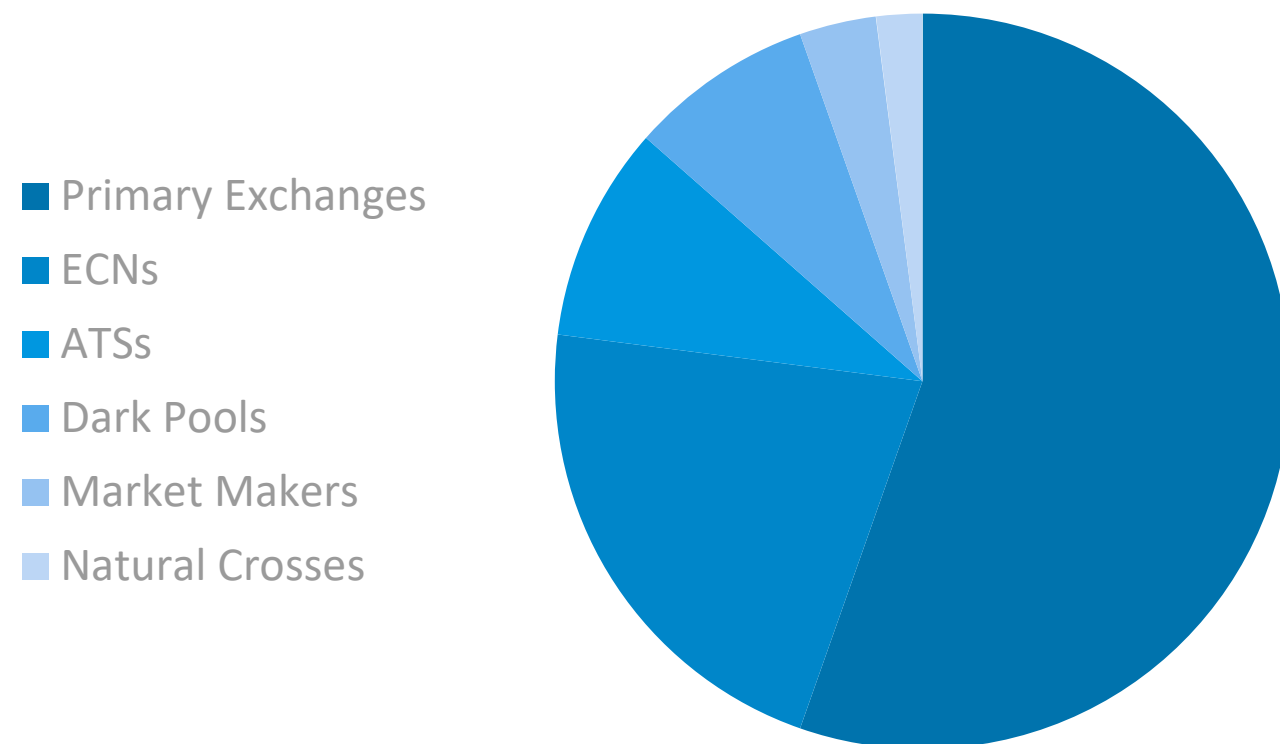
Abel Noser approaches each transition with one goal in mind: to consistently deliver measurably better executions.

Our industry-leading TCA platform and risk management tools are leveraged to the client's benefit, helping us to:

- Project execution costs with our proprietary model
- Manage risk by neutralizing largest exposures
- Vet venues empirically
- Identify highest quality algorithms
- Source liquidity for thinly traded securities
- Monitor executions and manage risk in real-time



Access to Global Equity Liquidity



- Market fragmentation has made it increasingly important that asset owners scrutinize where TM providers' liquidity is coming from.
- We have access to all global exchanges as well as non-displayed pools of liquidity (ECNs, ATSSs, dark pools, and market makers).

Venue Analysis and Routing Decisions

Our liquidity sources are vetted using our Universe of measured trades. This pool of data allows us to identify venue toxicity and discern which pools of liquidity routinely add value.

- Our TCA work informs our decision making process as it relates to liquidity sources, allowing us to route as efficiently as possible.
- We collect over 160 million fill-level data points per quarter and evaluate venues based on average fill size, latency, reversion, and spread capture. Importantly, we track retention by quartile so as to quantify the degree to which value add is persistent.
- This is a considerable advantage in navigating fragmented markets, both in aggregate and on a region, sector, and security-specific basis.
- As we do not have commercial interests in any liquidity venue, we can access all pools with the sole goal of best execution.

RankByPrincipal	Venue	FillCount	PrincipalUSD	AvgFillSizeUSD	MidPost01SecBP	MidPost60SecBP	MidPre01SecBP	MidPre60SecBP	SpreadCapturePerc	Venue Name
1	XNYS	25,295,532	223,875,194,728.34	8,850.38	-0.56	-0.51	-0.26	-0.93	49.6%	NEW YORK STOCK EXCHANGE, INC.
2	XOTC	4,818,350	158,959,748,839.29	32,990.49	-11.07	-10.97	-11.05	-11.34	33.1%	OTC BULLETIN BOARD
3	XNAS	14,549,079	129,725,420,147.05	8,916.40	-0.59	-0.40	0.28	-0.47	52.2%	NASDAQ - ALL MARKETS
4	ARCX	9,199,714	65,402,412,477.59	7,109.18	-0.46	-0.47	0.57	-0.46	58.2%	NYSE ARCA
5	IEGX	6,857,808	63,546,003,390.18	9,266.23	-0.76	-0.32	-0.71	-1.53	40.2%	INVESTORS EXCHANGE
6	XBOS	7,947,206	45,007,633,171.00	5,663.33	-0.25	-0.18	0.84	-0.11	66.1%	NASDAQ OMX BX
7	BATS	6,616,756	42,955,542,577.76	6,491.93	-0.20	-0.27	-0.12	-1.46	51.6%	CBOE BZX U.S. EQUITIES EXCHANGE
8	UBSA	4,004,244	41,976,636,623.75	10,483.04	-0.73	-0.10	-0.43	-0.89	44.0%	UBS ATS
9	EDGX	6,126,118	40,608,933,165.00	6,628.82	-0.39	-0.42	0.73	-0.47	62.6%	CBOE EDGX U.S. EQUITIES EXCHANGE
10	XADF	4,381,854	35,574,931,065.17	8,118.69	-1.36	-1.03	-1.40	-2.24	38.8%	FINRA ALTERNATIVE DISPLAY FACILITY (ADF)
11	LEVL	2,534,741	27,509,096,451.49	10,852.82	-0.72	0.17	-0.31	-1.19	38.4%	LEVEL ATS
12	EDGA	4,506,759	27,145,757,202.88	6,023.34	-0.24	-0.21	1.01	-0.08	69.6%	CBOE EDGA U.S. EQUITIES EXCHANGE
13	CDED	2,170,181	24,903,606,303.32	11,475.36	-2.12	-1.96	-2.07	-2.98	23.3%	CITADEL SECURITIES
14	XNGS	2,570,440	24,846,967,462.84	9,666.43	-0.15	0.31	-1.75	-3.62	38.8%	NASDAQ/NGS (GLOBAL SELECT MARKET)
15	BIDS	238,543	22,068,169,191.36	92,512.33	-0.03	0.41	0.09	-0.22	50.9%	BIDS TRADING L.P.
16	XNMS	2,823,283	20,412,564,279.81	7,230.08	-1.49	-1.71	-0.55	-1.86	66.7%	NASDAQ/NMS (GLOBAL MARKET)
17	BATY	4,476,960	19,976,436,633.60	4,462.05	-1.02	-0.69	-1.21	-2.23	41.9%	CBOE BYX U.S. EQUITIES EXCHANGE

Stock View

Stock Information
 Stock: LOCKHEED MARTIN CORP Ccy: USD
 Side: Buy Sell Date: 2019-05-06
 Shares: 100000 Report Ccy: USD
 Price: 334.07 Direction: Combined

Estimated Costs

	Amount	CPS	BP
Prior Close	\$-109,594	-109.59	-32.81
Open	\$-63,131	-63.13	-18.90
Entry Strike	\$-48,196	-48.20	-14.43
Placement	\$-47,878	-47.88	-14.33
VWAP	\$-14,530	-14.53	-4.35
Interval VWAP	\$-8,407	-8.41	-2.52
Available VWAP	\$-13,173	-13.17	-3.94
20% Test	\$-21,326	-21.33	-6.38

Market Cap: \$94,387,740,672 Sector: INDUSTRIAL
 Shares Outstanding: 282,538,809 Group: AEROSPACE DEFENSE
 Annualized Turnover: 72.26% Cap Style: LARGE CAP
 Average Spread: \$0.16 Stock Style: GROWTH

% of ADV: 12.34 Trade Size: 10 to 19.99%

Market	Venue	Sym...	ADV	Vo...	principal/day	shrs/tr...	trades...	trades...	ope...	clos...	CUSIP	ISIN
ALL	ALL	DR3E	828,263	100.00	\$258,490,049	173	4,775	12	18433	54	---	---
US	FINRA ADF	LMT	304,429	36.76	\$95,312,344	220	1,382	4	226	0	539830109	US5398301094
US	NEW YORK	LMT	234,221	28.28	\$72,650,016	324	723	3	17047	0	539830109	US5398301094
US	NASDAQ IM	LMT	101,433	12.25	\$31,714,926	109	932	3	33	0	539830109	US5398301094
US	EDGX EXCHA...	LMT	39,202	4.73	\$12,213,421	138	284	2	112	0	539830109	US5398301094
US	NYSE ARCA	LMT	30,166	3.64	\$9,511,368	120	251	2	39	0	539830109	US5398301094
US	INVESTORS EX	LMT	29,649	3.58	\$9,289,339	81	367	2	113	0	539830109	US5398301094
US	EDGA EXCHA...	LMT	24,335	2.94	\$7,585,983	104	233	2	125	0	539830109	US5398301094
US	CBOE BZX	LMT	23,622	2.85	\$7,413,231	111	211	1	101	0	539830109	US5398301094
US	CBOE BYX	LMT	17,788	2.15	\$5,508,245	103	173	1	100	0	539830109	US5398301094
US	NSDQ BX	LMT	14,361	1.73	\$4,482,581	107	134	1	101	0	539830109	US5398301094
US	NATIONAL	LMT	4,141	0.50	\$1,279,339	102	40	1	100	0	539830109	US5398301094
US	NSDQ OMX P...	LMT	2,426	0.29	\$764,671	118	20	1	106	0	539830109	US5398301094
US	NYSEAMERIC...	LMT	1,977	0.24	\$606,598	100	19	1	100	0	539830109	US5398301094
US	NYSE CHICA...	LMT	438	0.04	\$134,954	102	4	1	104	0	539830109	US5398301094
LN	LONDON	DR3E	75	0.01	\$23,034	36	2	1	26	54	539830109	US5398301094

Venue	Fill Size	Latency	Reversion	Spread Capture
Venue A	\$8,850	-0.26378	-0.50507	49.6%
Venue B	\$32,990	-11.04529	-10.97027	33.1%
Venue C	\$8,916	0.27757	-0.40100	52.2%
Venue D	\$7,109	0.57106	-0.47220	58.2%
Venue E	\$92,512	0.08545	0.41140	50.9%

Competitive Advantages

Abel Noser's award-winning analytics platform and long history of working on behalf of asset owners makes us the clear choice in the transition management space

TCA-Driven Process

- Our TCA research informs all aspects of our approach, allowing us to route orders to the most cost-efficient venues and deliver superior executions on behalf of our clients.

Over 30 Years of TM Experience

- Client service-oriented project management is at the heart of AN's TM offering. We strive to be a full-service transition manager, and not just an instrument of best execution. Our team helps asset owners avoid the pitfalls that can crop up in the early phases of the transition process. Our services add value in the planning stage as well as in the implementation stage.

Pure Agency Approach

- Our agency-only model is a vital safeguard against the conflicts of interest are inherent in other transition management models. Our sole objective is to act on our client's behalf and get the best possible price in the market.



Turning Trading Insight into Action

www.abelnoser.com

Thank you!



Telephone

1-646-432-4000
1-800-322-2610
(+)44 207 058 2109



Locations

New York, NY
Bethesda, MD
Los Angeles, CA

London, UK
Atlanta, GA

BlackRock[®]

Transition Management

BlackRock Transition Management -- LACERS Coverage



Jonathan Platt, CFA, Director, is Head of Americas Client Strategy in BlackRock's Transition Management team. He is responsible for managing a team of client strategists who advise institutional investors in the Americas on risk-managed portfolio transition solutions across multiple asset classes.

Prior to assuming his current role, Mr. Platt co-lead the Portfolio Management team within US TRIM and focused on the design and implementation of transitions for clients in the Americas.

Mr. Platt previously spent 13 years at BNY Mellon within the Beta & Transition Management team in both the San Francisco and London offices where he served as the Director of Portfolio Management. Additionally, Mr. Platt held past positions with Mellon Capital Management (business analyst) and Montgomery Securities (portfolio analyst).

Mr. Platt graduated from Florida State University with a B.S. in Finance and a B.A. in English.



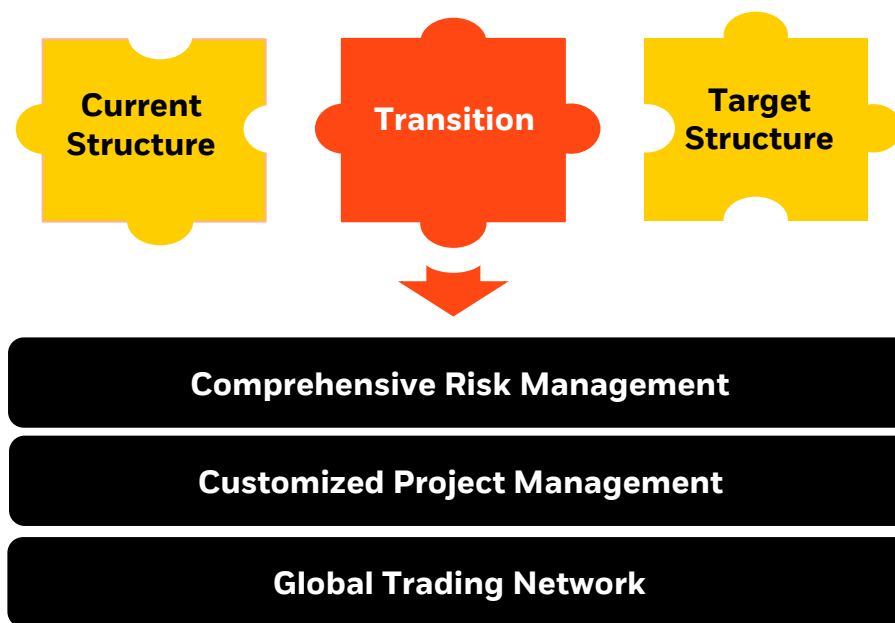
John Planek, Vice President, is a client strategist on the Transition Management (TRIM) team within BlackRock's ETF & Index Investments (EII) division. In this role he advises institutional investors in North America on multi-asset trading and risk management strategies during periods of portfolio or manager change.

John joined BlackRock in 2015 as a member of the Graduate Analyst program, after graduating from the University of Notre Dame with a BBA in Finance & Economics. He also graduated with an MBA from the University of Chicago in 2022.

Operating Model

BlackRock Transition Management Model

- Full fiduciary oversight with full transparency and no sell side conflicts
- Dedicated team of specialists focused exclusively on transitions
- Leverage BlackRock's risk analytics, portfolio management, and trading capabilities
- Based within the fiduciary environment of the world's largest asset manager



Key Capabilities

- Industry leading Aladdin risk management platform
- Transparent implementation reporting
- Agency-only multi-counterparty execution
- Scientific approach to trading

Experienced partner

- 60+ specialists globally*
- Integrated transition management systems
- Local presence in San Francisco, New York, London, and Hong Kong
- \$462 billion of transition flow in 2021**
- 213 transition events in 2021

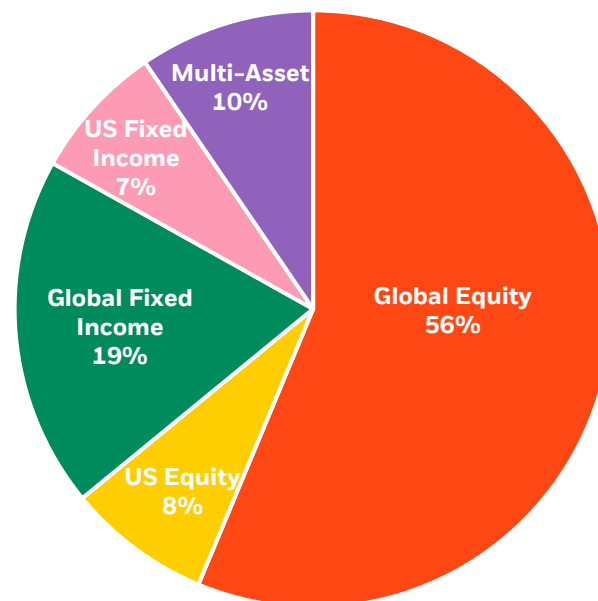
*as of June 30, 2022

**Full year 2021 round trip value

An Experienced Partner with Long Term Commitment to Core Business

- Core value added service since 1993
- Significant economies of scale transferred to our clients
- Global implementation services across all asset classes
- Fiduciary alignment of interests from the onset to execution

2021 Volume by Asset Class



Global 2021 Transition Volumes		
Asset Class	Transition RTV (in \$bil)*	Number of Events
Global Equity	\$259	106
US Equity	\$36	30
Global Fixed Income	\$89	39
US Fixed Income	\$33	16
Multi-Asset Class	\$45	22
Total Volume	\$462	213

Source: BlackRock *Refers to round trip value of assets transitioned

Index Equity & Portfolio Engineering Platform

Paul Whitehead
Managing Director
Co-Head of Index Equity & Global Head of
Portfolio Engineering & Platform

Global Transition Management

Jessica Irschick
Managing Director
Global Head of TRIM

Americas

Paul Francis
Managing Director
Head of AMRS TRIM

Will Jackson
Director
Head of AMRS
Portfolio Mgmt.

Chirag Lal
Vice
President
Head of AMRS
TM

Jon Platt
Director
Head of AMRS
Client Strategy

Laura Peres
Director
Head of AMRS
Product

Lorenzo Santinelli
Director

James Curtin
Vice
President

Christine Johanson
Director

Jose Tolosa
Director

Melinda Altamore
Associate

Aleesha Mundra
Associate

Karen Lindell
Vice
President

Ellen Zhang
Associate

Quinn O'Connor
Associate

Erick Alvarez
Analyst

Jonathan Pizano
Associate

Keon Modeste
Analyst

Adam Esposito
Director

John Planek
Vice
President

Dianne Chung
Vice
President

EMEA

Nick Hogwood
Managing Director
Head of International TRIM

Ian Maguire
Director
Head of EMEA
Portfolio Mgmt.

Jon Tait
Vice
President
Head of EMEA
TM

Adam Lubczanski
Director

Jonathan Deans
Vice
President

Steve Wagstaff
Director

Mikko Lindgren
Vice
President

Nicholas Fischer
Vice
President

Dickie Cheung
Vice
President

Isobel Murray
Associate

Calder Manser
Vice
President

Vivek Vishwanath
Vice
President

Ksenia Parviainen
Associate

Dominic Henry
Associate

Jamie Farley
Associate

Lauren Smith
Associate

Hunain Nadeem
Analyst

Balazs Bogdan
Vice
President

Matyas Ujvary
Associate

Aman Hammond
Associate

Dora Tarcali
Associate

Andrea Gidofalvy
Associate

Andy Gilbert
Managing Director
Head of EMEA
Client Strategy

Parul Sood
Vice
President

Adam Champion
Vice
President

Tom Hammond
Vice
President

Tahmimm Hassan+
Director
Head of Asia TRIM

Raymond Zhao
Vice
President
Head of Asia
Implementation

Sachiko Takahashi
Vice
President

Michael Xu
Vice
President

Matthew Walton
Vice
President

Junya Umeno++
Managing Director
Japan Client
Strategist

Yuki Tanaka
Vice
President

Esther Tay
Vice
President

+ Direct line to N. Hogwood (Regional Head)

++J. Umeno direct line to H. Arita (President of BlackRock Japan)

• Source: BlackRock as of September 2022

ETFs and Index Investments (EII) Investments Pillar

Salim Ramji
Global Head of ETFs and Index Investments

Investments Pillar

Samara Cohen
Chief Investment Officer of ETF and Index Investments

Index Equity

Jennifer Hsui, CFA, Global CIO and Co-Head of Index Equity

Paul Whitehead, Global Co-Head of Index Equity

Global Research

Nogie Udevbulu
Global Head of
EII Research

**Index & Quantitative
Research**
+ 15 Researchers

Analytics Research
+ 39 Research Officers

Strategy

Scott Dohemann, CFA
Head of
U.S. Product Strategy
+ 6 Strategists

Office of the CIO

Tim Parsons, CFA
Deputy CIO
+ 4 Portfolio Engineers

Jonathan Van Ginneken
Head of Investment
Innovation &
Global Index Plus
+ 5 Portfolio Engineers

Steven White
Head of Performance,
Risk & Index Advocacy

Portfolio Engineering

Americas

Amy Whitelaw
Head of Americas
Portfolio Engineering

Suzanne Henige, CFA*
Head of US-listed ETF
PE
(US, Developed,
Emerging)
+ 17 Portfolio Engineers

Matthew Waldron, CFA
Head of Developed &
Emerging Markets
Institutional PE
+ 10 Portfolio Engineers

Peter Sietsema, CFA
Head of Sub-Advised, US
Institutional, and
Canada/LatAm ETF PE
+ 17 Portfolio Engineers

Index Asset Allocation, Commodities, Synthetics

Greg Savage, CFA
Head of Global IAA,
Commodities & Synthetics

Peter Tsang
Head of Americas IAA
+ 5 Portfolio Engineers

Steve Walker
Head of EMEA IAA
+ 6 Portfolio Engineers

Kyle Peppo
Head of Commodities &
Synthetic Indexing
+ 2 Portfolio Engineers

Orlando Montalvo
Head of FX & Synthetics
+ 3 Portfolio Engineers

Platform

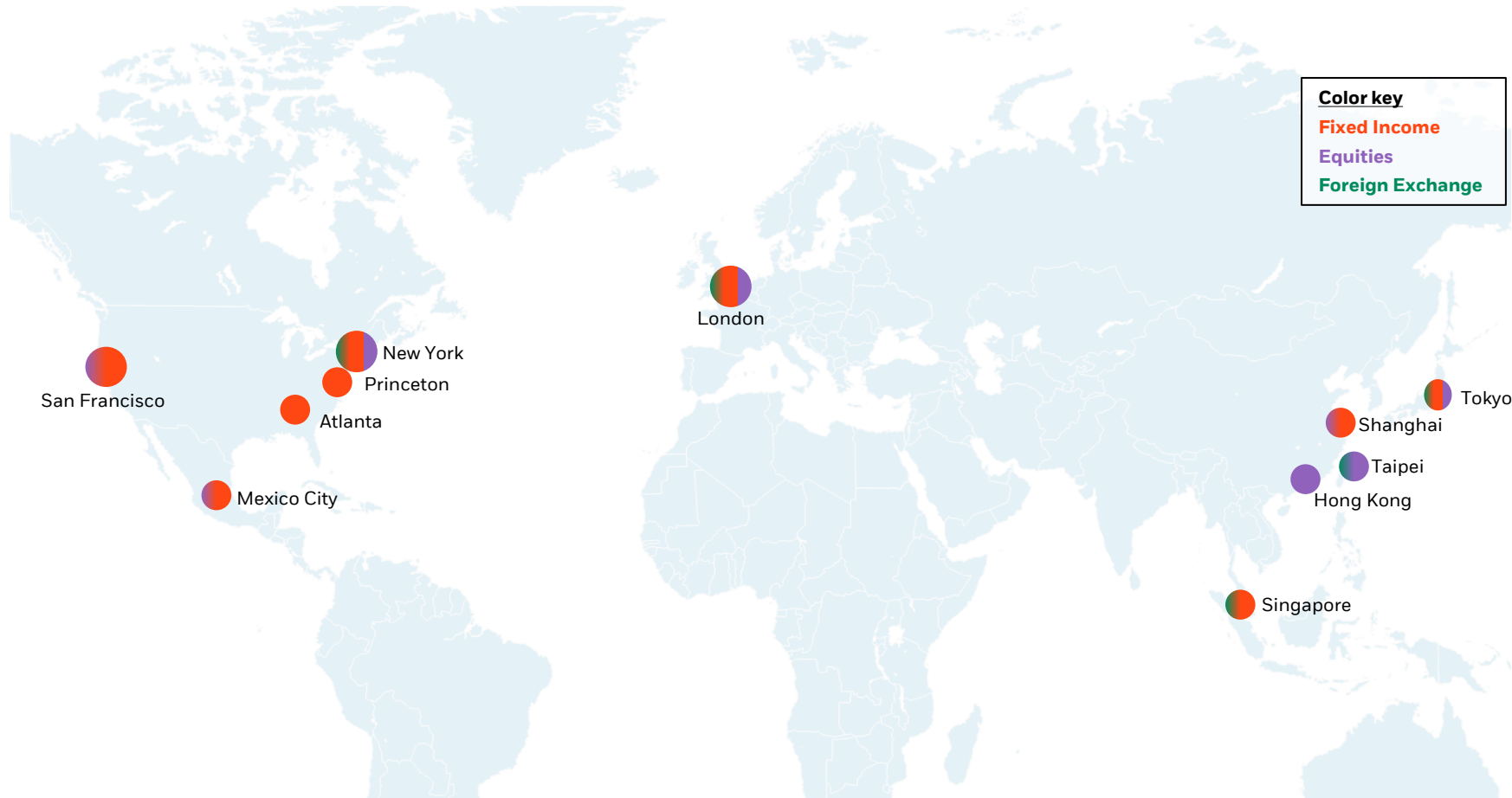
Rajesh Nagella
Global Head of EII
Investment Process & Platform
+ 5 Platform Engineers

Transition Management

Jessica Irschick
Global Head of
Transition Management
+ 58 Transition Specialists

As of 30 June 2022. *Asterix indicates location in Atlanta (total EII team of sixteen investment professionals stationed in Atlanta).

Global Trading Coverage with Local Expertise



One Order Management System platform: Aladdin Dashboard

Regional hubs for each asset class with local market knowledge and sector expertise

Common technology enables us to pass the book with embedded business continuity plan

24 hour a day, 5.5 days per week coverage

As of December 31, 2021. Source: BlackRock.

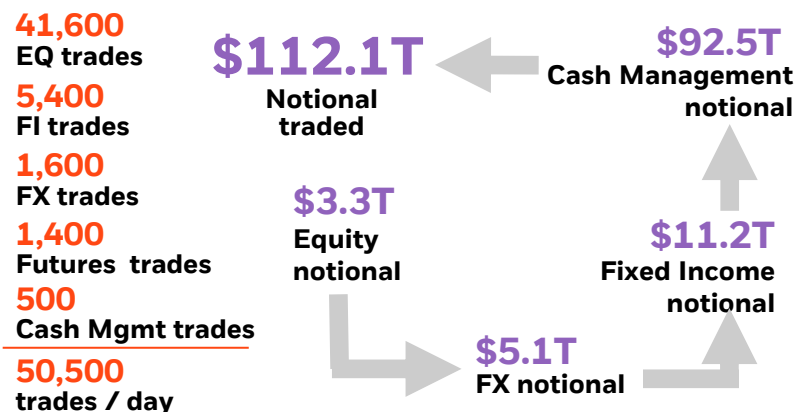
Execution: Seek to reduce costs by leveraging pricing power on a single, global platform

The advantage of scale

- **Tier 1 client to all major counterparties** which we believe uniquely positions us to access liquidity
- **24-hour global agency trading platform** to enable trading at times of maximum liquidity and to leverage local market knowledge and sector expertise
- Trader expertise across all major asset classes and **~\$112.1T of annual volume¹**
- Large volumes and breadth of clients provides **potential opportunities for crossing securities**, reducing transaction costs

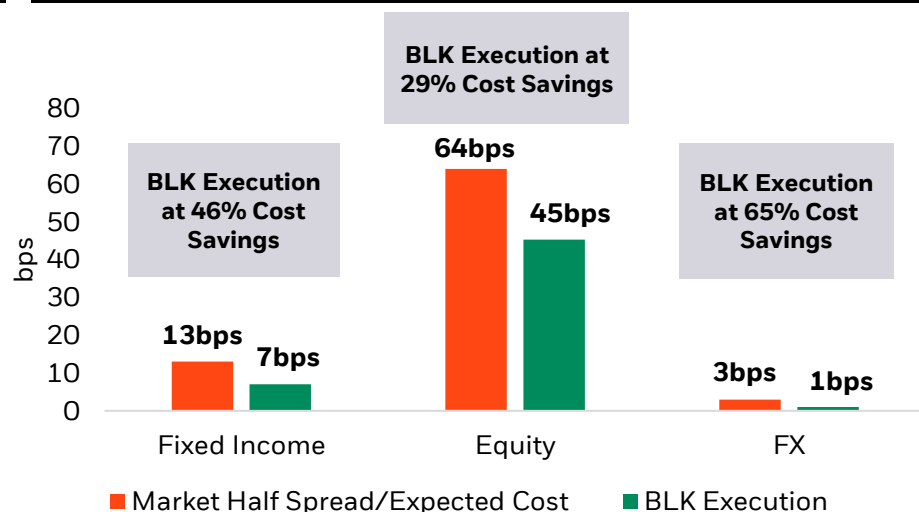
Result: Potential execution benefits can be passed directly on to clients as cost savings

BlackRock's Execution Activity¹



Excludes iShares Create/Redeems activity. Notional traded excludes futures and trade count represents number of block trades.

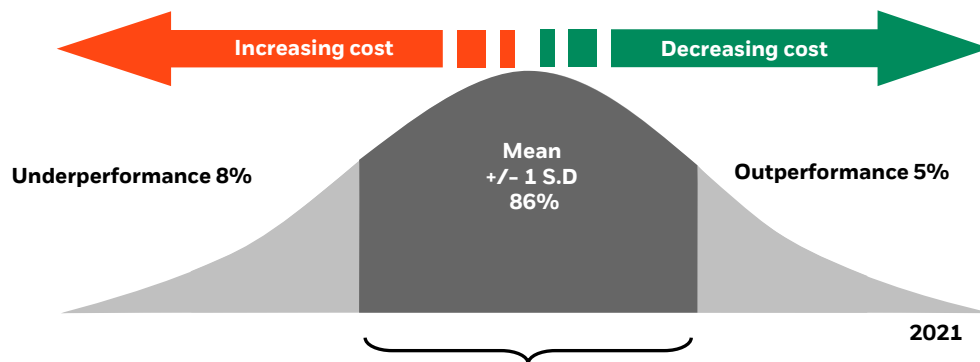
Execution Costs: BlackRock versus the Market²



¹ Average activity for 2021, as of 12/31/2021; Figures show in USD; Source: BlackRock. Inclusive of internal crossing opportunities. Numbers may not add up to total due to rounding. ² BlackRock analysis of all Fixed Income High Yield and Investment Grade Credit, FX, and Equity trades excluding derivatives for 2021 as of 12/31/2021. BlackRock Execution Cost is the average difference between: the actual price achieved on the trade and the benchmark price. For Equity and FX, benchmark price is the market price, based on exchange data at the time when the PM submitted the order. For Fixed Income, benchmark price is the previous day's closing price. The Market Half Spread (or Expected Cost) is an estimate of the average execution cost of a market participant. For Fixed Income, Market Half Spread is estimated quarterly for each sector and maturity bucket based on a consensus opinion of BlackRock traders as well as a set of over 10 broker dealers. For FX, brokers provide Market Half Spread quarterly on a consensus basis for each currency pair and size range. For Equity, BlackRock calculates Market Expected Cost using an average of multiple independent broker models. There is no guarantee that a positive investment outcome will be achieved. Subject to Change.

Our Track Record

- Asset classes: Developed and Emerging Equities, Government Bonds, IG & HY Credit, EMD, Futures, FX
- Clients: Asset Managers, Pension Funds, Insurance Companies, Sovereign Wealth Funds
- Mandates: Manager and benchmark changes, Portfolio constructions and liquidations, Interim management
- Approx. 213 assignments in 2021



86% of results fell within one standard deviation

Implementation Shortfall actual versus estimated	2012	2013	2014	2015	2016	2017	2018	2019	2020	2021
Shortfall results within one standard deviation	77%	83%	82%	81%	81%	84%	75%	79%	85%	86%
Shortfall results less than -1 standard deviation (outperformance)	18%	11%	11%	11%	8%	10%	9%	12%	5%	5%
Shortfall results more than +1 standard deviation (underperformance)	5%	6%	7%	8%	11%	6%	16%	9%	10%	9%
Shortfall results equal to or better than central estimate	60%	58%	58%	57%	51%	59%	56%	55%	60%	47%

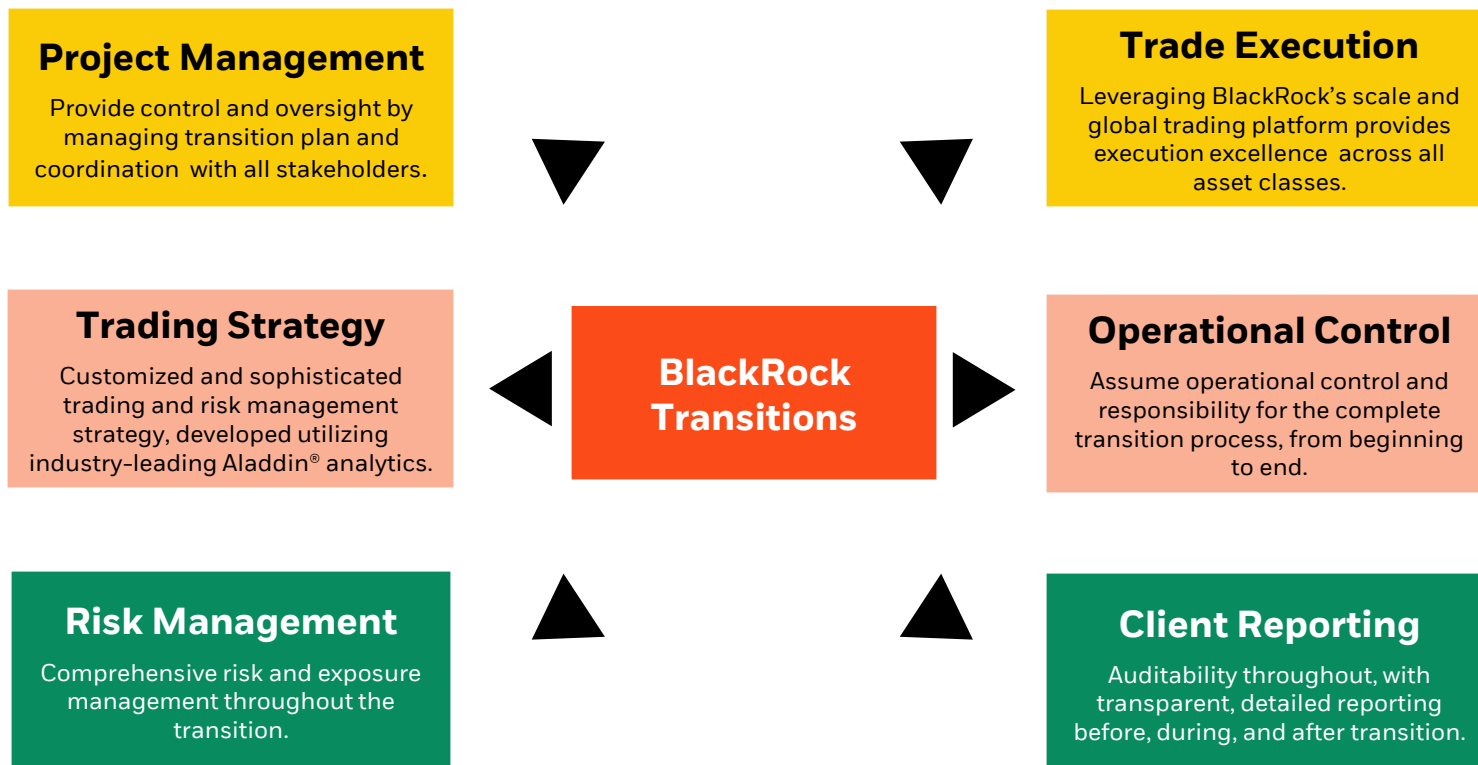
Source: BlackRock. Based on actual results from all transitions completed during 2012– 2021

For illustrative purposes only. This example is not intended to represent that such results will occur in all cases.

Global Track Record

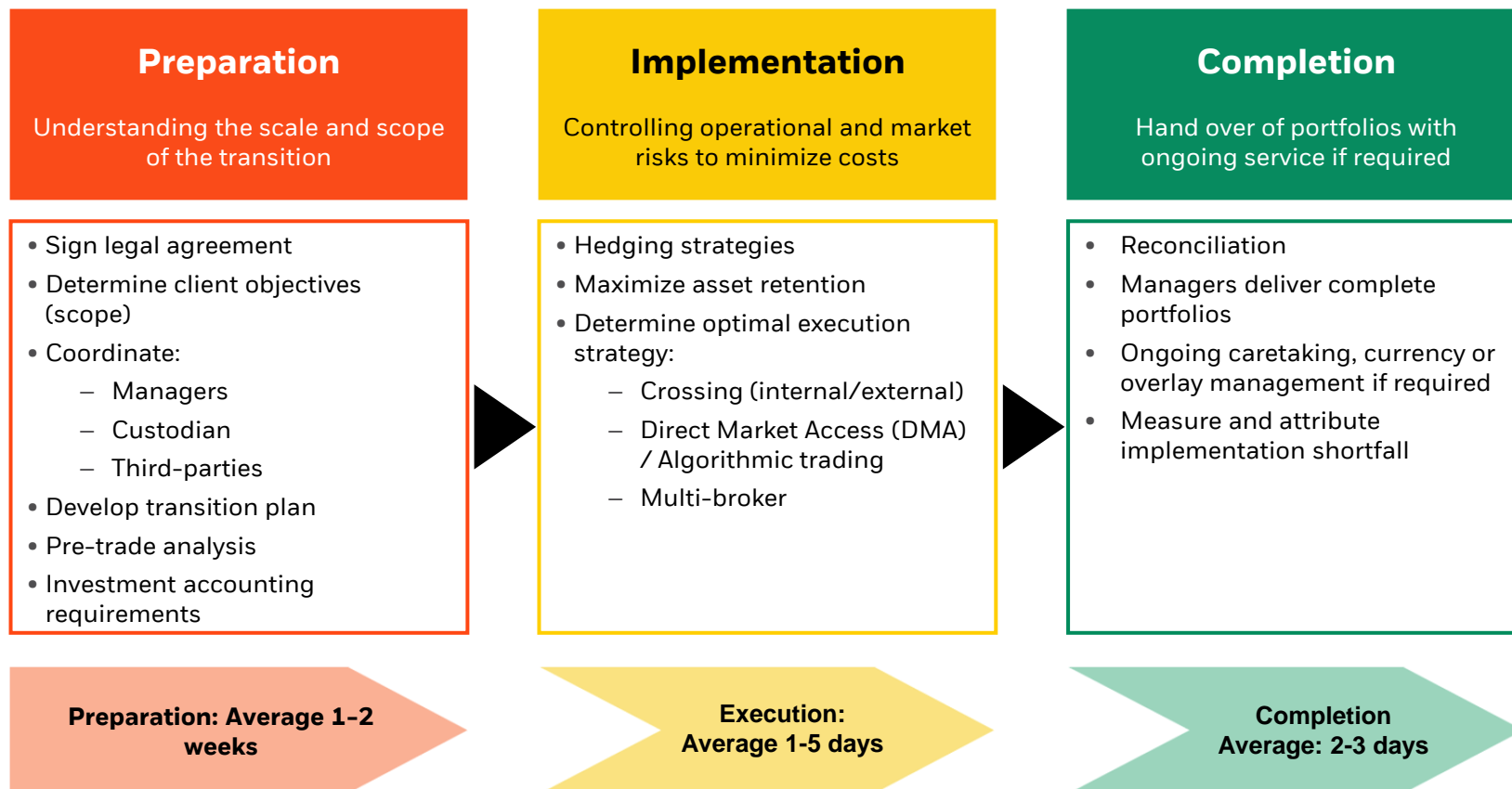
Full-Service Offering

Full-service transition management offering



Transition Management Process

Comprehensive project management throughout the entire process



Risk managed process controlled by dedicated project team

Preparation

Transition timeline and calendar

- BlackRock analyzes client requirements and provides:
 - A detailed project timeline to relevant parties
 - BlackRock will research the anticipated trading window for market holidays, economic news, and other important events

Client Name					
Global Multi-Asset Rebalance					
Monday	Tuesday	Wednesday	Thursday	Friday	
9/2/2019	9/3/2019	9/4/2019	9/5/2019	9/6/2019	
BlackRock hosts call between Target Manager and Custodian Mellon to discuss the transition and finalizes the target contribution date.				The Client provides required LOD to Legacy Stakeholders (Legacy Manager)	
BlackRock provides updated timeline to all stakeholders					
9/9/2019	9/10/2019	9/11/2019	9/12/2019	9/13/2019	
The Client provides required LOD to Legacy Stakeholders (Manager and Custodian)			BlackRock redeems from the Legacy Manager Fund with TD Sept. 19 and SD Sept. 24	Legacy Manager wires approx. \$4M or C\$5.3 to BlackRock to cover futures collateral	
			BlackRock equalizes for cash markets to maintain appropriate market exposure	Legacy Manager provides finalized inkind to Custodian and BlackRock for the asset transfer	
9/16/2019	9/17/2019	9/18/2019	9/19/2019	9/20/2019	
Legacy Manager finalizes the redemption and provides unit details to all stakeholders	Custodian delivers inkind assets and remaining cash to Target Manager	BlackRock reconciles assets with Custodian and prepares trading solution	BlackRock executes the required hedges at Benchmark	BlackRock begins the broader transition	
BlackRock coordinates with target managers to receive finalized wish lists	Custodian provides reconciled asset list to BlackRock	Custodian continues providing additional reconciled lists for any pending items	Custodian continues providing additional reconciled lists for any pending items		
BlackRock takes assets onto Aladdin Investment Platform					
9/23/2019	9/24/2019	9/25/2019	9/26/2019	9/27/2019	
Transition trading continues	BlackRock completes all required trading		Last day of market settlement for all transition equity trades		
BlackRock provides the final asset list to target managers and Custody Bank for the contribution					
BlackRock		BlackRock Contacts Transition Manager 1 Transition Manager 2 Strategist	tm.manager.1@blackrock.com tm.manager.2@blackrock.com strategist@blackrock.com	1 646 123 4567 1 212 123 4567 1 415 123 4567	Legend Cash Activity Terminations / Redemptions Trading Begins

Confidential

Project accountability and risk control

For illustrative purposes only

Preparation

Pre-transition report

- BlackRock provides the client with a detailed pre-transition report consisting of:
 - An assessment of expected costs and risk
 - A review of recommended trading strategy
 - Key considerations for the transition
- In developing an implementation strategy, we consider the following:
 - Liquidity
 - Expected tracking error
 - Impact of hedging
 - Cash flow and operational considerations

BlackRock
Transition Management

Thursday, October 3, 2019
Client
Global Multi-Asset Rebalance
Pre Trade Report Initial Fund Value: USD 122.5m

Transition Overview

Overview
The Client is looking to rebalance an active US equity portfolio into a Russell 1000 growth committed fund. We have analyzed the costs and risks of the proposed restructuring and present the results of the analysis in the report that follows. Our analysis is based on the legacy and target assets provided by Client, and a representative slice of the target Russell 1000 Growth index.

BlackRock Objectives

- 1) Implement a customized trading strategy to minimize cost and risk during the transition
- 2) Source liquidity from a wide variety of counterparties via a competitive bidding process to minimize costs
- 3) Provide full service project management throughout the transition period

A strategy discussion as well as further details of the costs and risk associated with the transition are outlined in the following pages.

Transition Structure

Legacy

Manager 1
Global Equity 201M

Asset Class Summary

	Legacy Value
Equity	85,075,706
Fixed Income	23,420,507
Cash	6,939,980
Total Value	115,299,293

Transition by the Numbers

8.30%

32%

12%

\$203m

Thursday, October 3, 2019
Client
Global Multi-Asset Rebalance
Pre Trade Report Initial Fund Value: USD 122.5m

Estimated Transition Cost

Equity Trading Costs					
	Sell	Buy	Total Cost	% of Legacy Portfolio Value	% of Equity Traded Value
Commission	-51,133	-15,707	-66,840	(0.05)	(0.04)
Tax	-1,161	-7,009	-8,169	(0.01)	(0.00)
Spread	-10,842	-10,816	-21,658	(0.02)	(0.01)
Market Impact	-187,764	-202,585	-390,349	(0.33)	(0.10)
Dev FX Costs	-46	-448	-494	(0.00)	(0.00)
Total Costs	-230,926	-34,073	-264,999	(0.23)	(0.16)

Fixed Income Trading Costs					
	Sell	Buy	Total Cost	% of Legacy Portfolio Value	% of FI Traded Value
Commission	-1,128	-6,807	-7,935	(0.01)	(0.04)
Spread & Impact	-9,565	-89,221	-98,786	(0.08)	(0.30)
Total Costs	-10,693	-96,028	-106,721	(0.09)	(0.54)

Implementation Shortfall Estimate

	Total Cost	% of Legacy Portfolio Value	% of Traded Value
Opportunity Risk (-/-)	582,142	0.46	0.31
Implementation Shortfall - lower cost estimate (1 a)	110,422	0.14	0.09
Implementation Shortfall - higher cost estimate (1 a)	-95,346	(0.78)	(0.53)
Implementation Shortfall - lower cost estimate (2 a)	732,563	0.60	0.41
Implementation Shortfall - higher cost estimate (2 a)	-1,516,003	(1.24)	(0.84)

Implementation Shortfall (bps)

--- Central IS Estimate

■ 1std Range (50% of outcomes)

■ 2std Range (95% of outcomes)

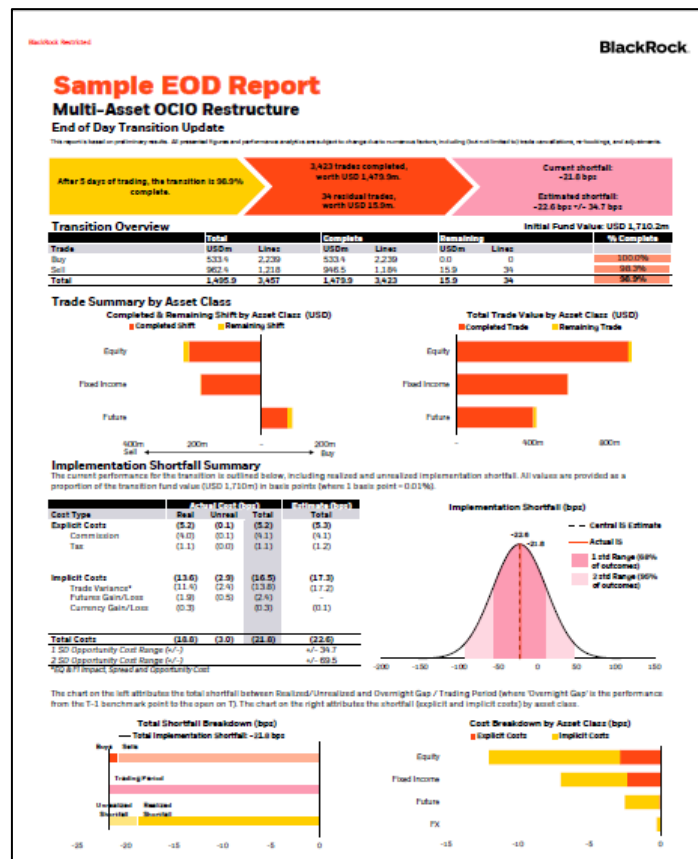
The above pre-trade cost estimate assumes that market returns are normally distributed. However, returns within equity markets are frequently observed to exhibit characteristics which do not fit a normal distribution and therefore outliers in IS may occur more often than expected by the theoretical normal distribution.

For illustrative purposes only

Implementation

Daily reporting

- Throughout the transition, BlackRock provides the client with a daily brief, covering:
 - Key project updates
 - Operational updates on settlement and relevant account setup
 - Updates on project coordination with the custodian and managers
 - A clear summary of the outstanding action points
- The daily brief provides consistent clarity and a project audit trail



Transparency at all stages of the transition

For illustrative purposes only

Trading Research Overview

Trading Analysis & Research (TAR)

- BlackRock's Trading Research team is a global team of over 15 people*
- The team maintains the TAR database, which provides the basis for our:
 - Modelling and Research (t-cost forecasts)
 - Pre-Trade applications (MPO, Principal bid)
 - Post-Trade analysis
- Additionally, TAR makes it possible to dynamically extract the performance of each counterparty by:
 - Asset class
 - Region
 - Market sector
 - Name
- TAR brings together the pre-trade perspective, execution and investment performance, and post-trade analysis

Research-driven approach to trading

* As of June 30, 2022

BlackRock Transition Management Systems

Aladdin Transition Manager (ATM)

- Designed by Transition Managers for Transition Managers
- Takes care of the heavy lifting
- Fully integrated Aladdin application:
 - Truly global system – all transitions can be viewed across the world
 - Completely seamless with portfolio management and order management systems
- Multiple account management functionality including aggregation and crossing across client accounts

Legacy Portfolios

Portfolio Ticker	Portfolio Name	Risk Benchmarks	Allocation Order
B ATRNTTL		B ATRNTB1, NULLBNCHEU	1

Target Managers

Target Name	Portfolio Ticker	Allocation Order	Target Name ID
New Target Manager 1	B ATRNTTL		1 Target Manag...

Minimize spreadsheet work and process risk

Screenshot for illustrative purposes only

BlackRock Transition Management Systems

Portfolio Construction (PfC)

- The portfolio management tool used by all of BlackRock
- Multi-asset modelling – equities, fixed income, futures and FX
- Fully integrated Aladdin application:
 - Truly global system – all transitions can be viewed across the world
 - Fully integrated with order management systems
 - Fully integrated with cash management systems

PORTFOLIO CONSTRUCTION Aladdin

File Options View Action History Format Help Workspace: TRIM Default View July 2015

08-OCT-2020 - 12:46:09PM As Ordered and Traded w/Proposed - 1 pf 251 pos, 16 trd, 6 ord, no cf - 1 distinct bench 72 pos, no trd, no ord, no cf

Port Group: <Port Filter> Bench: Primary Date: T+10 Ccy: USD Filter: Issuer (family) LT

Main Window **Sector View** Currency by KR D Orders Detailed Holdings View

Sector View (All)

Search: (TRIM_MULTIASSE...) All

Buttons: Sort Pivot

	Pf	Qty	Bench	Qty	Active	Qty	Active	New Qty	Pf	New Qty	Pf	Base MV	Bench	MV	Active	MV	Active	New MV	Pf	New MV	Pf	Exp	B
▼ Cash & FX		11,488,137	5,845,210	5,642,927	5,642,927	11,488,137	USD	11,341,589	USD	5,845,210	USD	5,496,380	USD	5,496,380	USD	11,341,589	USD	11,341,589	USD				
> Cash & Cash Equivalents		-34,141,494	5,845,210	-39,986,704	-39,986,704	-34,141,494	USD	11,246,111	USD	5,845,210	USD	5,400,902	USD	5,400,902	USD	11,246,111	USD	11,246,111	USD				
> FX Forwards		45,629,631		45,629,631	45,629,631	45,629,631	USD	95,478	USD		USD	95,478	USD	95,478	USD	95,478	USD	95,478	USD				
> Equity		27,880,430	27,880,430	0	0	27,880,430	USD	196,578,929	USD	196,578,929	USD	0	USD	0	USD	196,578,929	USD	196,578,929	USD				
🏠 Totals		39,368,567	33,725,640	5,642,927	5,642,927	39,368,567	USD	207,920,519	USD	202,424,139	USD	5,496,380	USD	5,496,380	USD	207,920,519	USD	207,920,519	USD				
Grand Totals		39,368,567	33,725,640	5,642,927	5,642,927	39,368,567	USD	207,920,519	USD	202,424,139	USD	5,496,380	USD	5,496,380	USD	207,920,519	USD	207,920,519	USD				

Proposed Orders: Unsent (0) Existing (6)

Orders Warnings Cor

Market leading portfolio management systems

Screenshot for illustrative purposes only

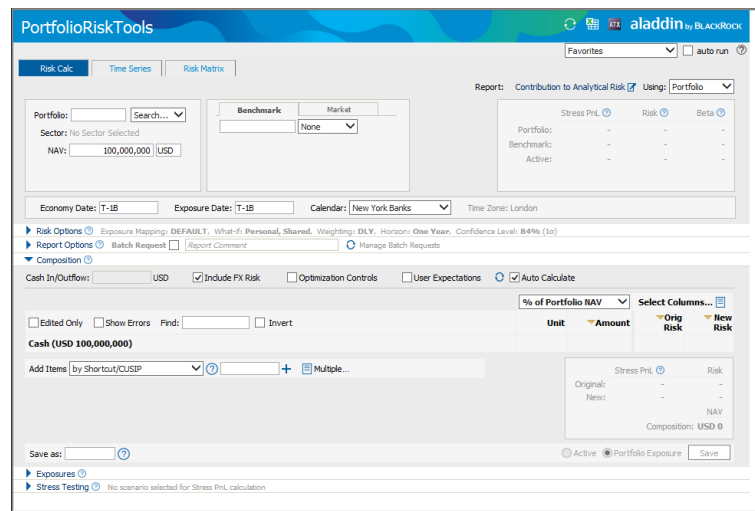
Risk Management & Analytics

Access to Aladdin® risk and investment platform

- Highly scalable investment management platform combining:
 - Portfolio analysis
 - Risk management tools
- BlackRock provides Aladdin technology on over 1000 assignments around the world*

BlackRock Transition Management utilizes Portfolio Risk Tools (PRT) and Green Package

- Tracking error calculation
- Dynamic hedging and risk optimization
- Risk decomposition
- Multi-asset class capability
- Futures basket optimization



Green Package							
Contribution to Active Risk & Pnl Attribution What-if Portfolio .BPL							
Portfolio	Exposure Date	Exposure Hierarchy	Purpose	NAV	CCY	DxS Block	
.BPL vs. .BPT	8/15/2016	cmrser.BP_VIP_*/WRLDA_DEFAULT	BR_VIP*	1,580,991,210	GBP	ALL_DXS	
Risk Group	Factor Level	Factor Val	Credit Beta	Exposure	Stand-alone Risk	Risk Contribution	
GBP Int Rates		matrix...		523	794	491	
GBP 3M	0.18	34	8.02	1	1	0	
GBP 1Y	0.13	46	-0.37	17	-6	-6	
GBP 2Y	0.11	56	0.61	34	17	17	
GBP 3Y	0.11	75	-0.08	6	-3	-3	
GBP 5Y	0.24	87	1.14	99	66	66	
GBP 7Y	0.42	89	0.86	76	53	53	
GBP 10Y	0.77	93	1.38	129	93	93	
GBP 15Y	1.12	99	1.47	145	112	112	
GBP 20Y	1.39	104	1.16	121	97	97	
GBP 25Y	1.50	107	0.95	102	82	82	
GBP 30Y	1.40	101	0.43	44	34	34	
GBP 40Y	1.26	97	0.32	31	24	24	
GBP 50Y	1.18	99	0.12	12	9	9	
USD Int Rates		matrix...		-5.35	349	-41	
Txy 3M	0.32	23	-0.01	0	0	0	
Txy 1Y	0.63	32	-0.07	2	0	0	
Txy 2Y	0.75	50	-0.13	7	0	0	
Txy 3Y	0.90	59	-0.35	21	-1	-1	
Txy 5Y	1.20	68	-0.73	50	-4	-4	
Txy 7Y	1.43	70	-0.92	64	-8	-8	
Txy 10Y	1.64	70	-0.86	60	-9	-9	
Txy 15Y	1.88	71	-0.41	29	-6	-6	
Txy 20Y	2.10	70	-0.56	39	-9	-9	
Txy 25Y	2.31	68	-0.72	49	-12	-12	
Txy 30Y	2.49	67	-0.61	41	-11	-11	
DEM Int Rates		matrix...		-1.42	64	-23	

Market-leading risk management analytics drive implementation strategy

*As of December 31, 2021. Screenshot for illustrative purposes only

BlackRock Transition Management Systems

Aladdin Dashboard

- Order management tool used by all of BlackRock
- Complete visibility of all orders through trade lifetime from initial order to settlement
- FIX connectivity provides real time data
- Fully integrated Aladdin application:
 - Integrated with Portfolio Construction
 - Multi-asset class orders – equity, fixed income, cash, foreign exchange, and futures
 - Integrated with cash management systems and cash fund systems
 - Seamless connectivity to execution management systems through Flextrader (Equity & FX), Tradeweb (FI), MarketAxess (FI) and FX Connect (FX).
- Includes future corporate actions

The screenshot displays the Aladdin Dashboard interface with several data tables. The top section shows 'Orders Awaiting Trade Pickup' with columns for PM/Team, Basket, Portfolio, PM, Trader, Transx Type, Sec Ccy, Assigned To, Asset ID, ISIN, SEDOL, Description, Ticker, and Quant. Below this is a table for 'Orders Being Traded' with columns for Filters, % Filled, PM, Trader, Transx ID, Asset ID, ISIN, SEDOL, Sec Ccy, and Description. The bottom section shows a 'Trades' table with columns for Portfolio, Status, Trader, Transx, Asset ID, ISIN, SEDOL, Sec Ccy, and Security Description.

Portfolio	Status	Trader	Transx	Asset ID	ISIN	SEDOL	Sec Ccy	Security Description
Confirmed	(2/3)	BUY	(8/8)	(8/8)	(8/8)	(8/8)	USD	(8/8)
Confirmed	DNV	BUY	65234MCT	US65234...	81111076	USD	HEXON INC 6-4 5/15/27	
Confirmed	YS	BUY	50079A08	US50079...	8031091	USD	KRAFT HEINZ FOODS CO 3 4/1/26	
Confirmed	YS	BUY	883556B1	US88355...	8007311	USD	THERMO FISHER SCIENTIFIC INC 3 4/15/23	
Confirmed	YS	BUY	25466A03	US25466...	8021419	USD	DISCOVER BANK 4 3 8/8/23	
Confirmed	YS	BUY	14640B33	US14640...	8105112	USD	CAPITAL ONE FINANCIAL CORPORATION 4...	
Confirmed	YS	BUY	91324CPS	US91324...	8111109	USD	UNITEDHEALTH GROUP INC 3 75 7/15/25	
Confirmed	YS	BUY	65537KASZ	US65537...	80967K2	USD	MORISEA BANK AB 2 25 3/27/21	
(2/2)	Confirmed	(5/10)	(2/10)	(8/10)	(8/10)	(2/10)	(10/10)	

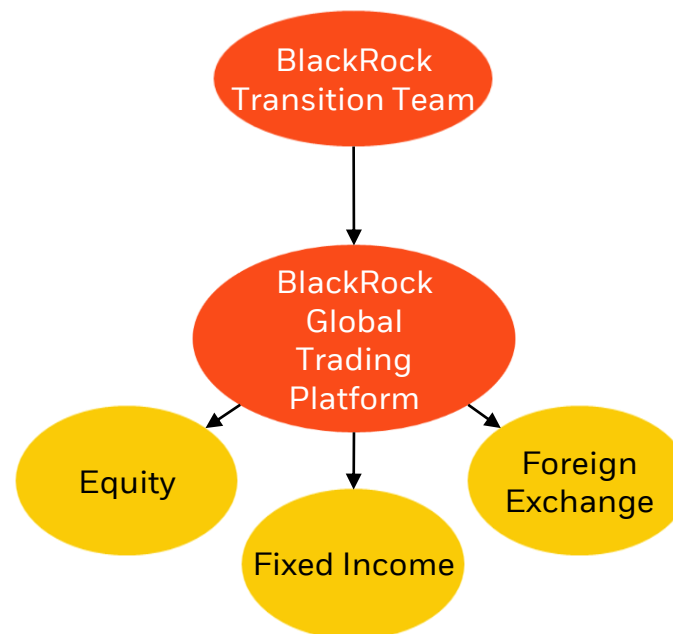
Real time visibility of global executions

Screenshot for illustrative purposes only

Transition Execution Quality

Global Trading Platform

- BlackRock operates an agency open-architecture trading platform in order to source best execution in:
 - Equity
 - Fixed Income
 - FX
 - Futures
- Our transition management team leverages BlackRock's global trading platform and the expertise of our traders across different markets
- Our clients benefit from the pricing that BlackRock's size and scale brings
- BlackRock executes transition trading on an agency basis

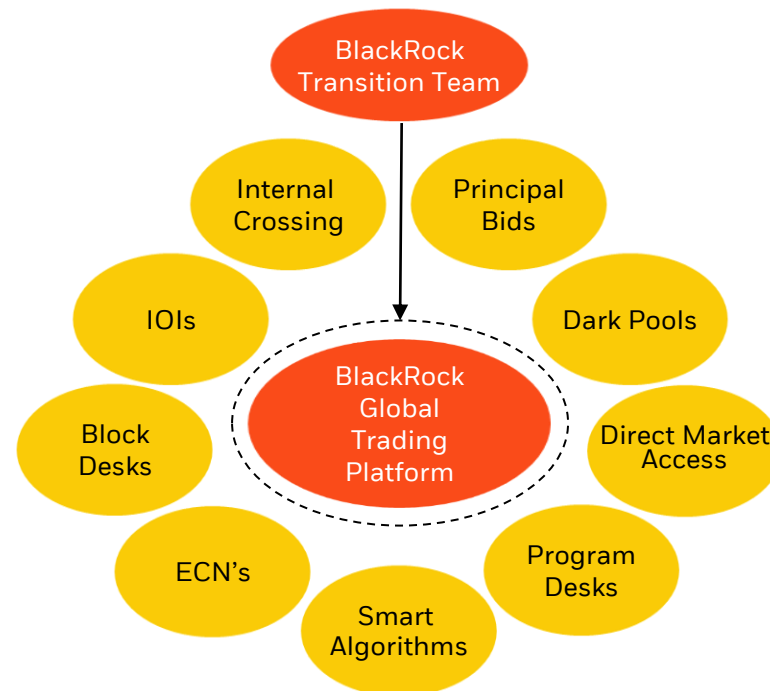


Market access via multiple venues to achieve best execution

Transition Execution Quality

Equity Trading

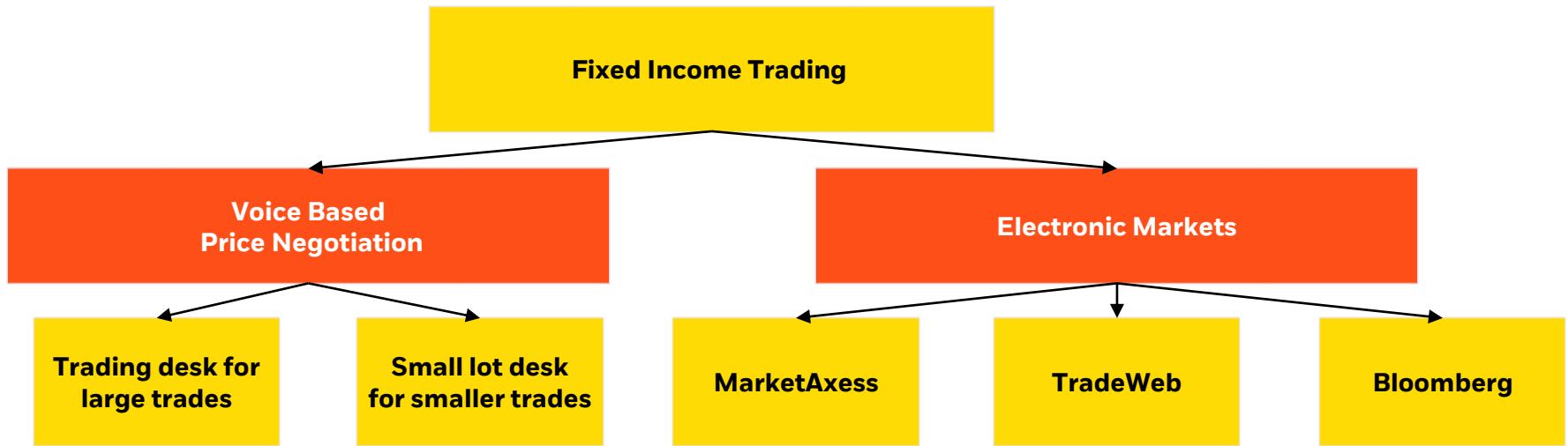
- BlackRock uses a pure agency open-architecture platform with direct market access to all key markets
- The range of available brokers and algorithms allows efficient routing of trades to the best counterparty for each region, market, equity type (large cap / small cap), etc.
- Our Trading Research Group provides a scientific structure to determine the best approach for each scenario
- Over 200,000 Indications of Interest (IOIs) are received globally on a daily basis, helping to trade less liquid positions cost effectively while maintaining client confidentiality. BlackRock does not provide outgoing Indications of Interest



BlackRock's open-architecture platform provides vast access to liquidity

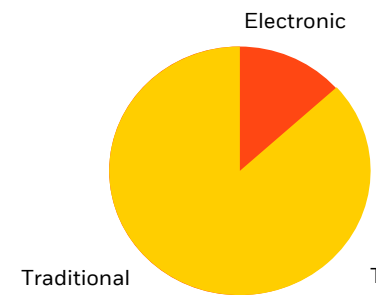
Source: BlackRock as of December 31, 2021

Fixed Income Trading

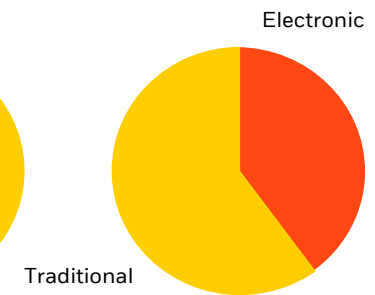


- A large part of the fixed income market is traded over the counter and is comprised of fairly complex instruments, so the market is dominated by over-the-phone transactions
- We also utilize the appropriate electronic markets and platforms for trading in specific asset classes

Credit Notional



Credit Trade Count/Line



BlackRock Recent Credit Volumes by Venue

For illustrative purposes only

Transition Execution Quality

Fixed Income Trading

- Access to more than 100 brokers (wholesale & specialists) and electronic order platforms (MarketAxess, Tradeweb, etc.)
- Trillions of USD fixed income traded annually
- Efficient process for receiving and analyzing Indications of Interest (IOI)

Indication (41880/35580) ✕									
[Asset ID]	Status	Side	Actual Qu... (Abs)	Ticker	Price Type	Spread	Price	Modified Time	Cpty
064255AS1			4,187,000		Spread	35.4066666...	38.61		(2/3)
064255AS1	Traded	Sell	580,000		Spread	42.3	42.3	02-10 12:56:56	MKTX
064255AS1	Active	Offer	107,000		Spread				
064255AS1	Traded	Buy	3,500,000		Spread				
62718QAA3			26,613,000		Spread	66.			
62718QAA3	Active	Offer	5,000,000		Spread				
62718QAA3	Traded	Buy	200,000		Spread				
62718QAA3	Active	Offer	175,000		Spread				
62718QAA3	Traded	Sell	2,000		Spread				
62718QAA3	Active	Offer	20,711,000		Spread				
62718QAA3	Traded	Buy	275,000		Spread				
62718QAA3	Traded	Sell	250,000		Spread				
63254AAB4			3,252,000		Spread	17.			
63254AAB4	Active	Offer	1,000		Spread				
63254AAB4	Active	Bid	1,000		Spread				
63254AAB4	Traded	Buy	3,250,000		Spread				
BRSE5PVX3	Active	Offer	15,090,000		Spread				
BRSE5PVX3	Active	Offer	5,090,000		Price				
BRSE5PVX3	Active	Offer	10,000,000		Price				

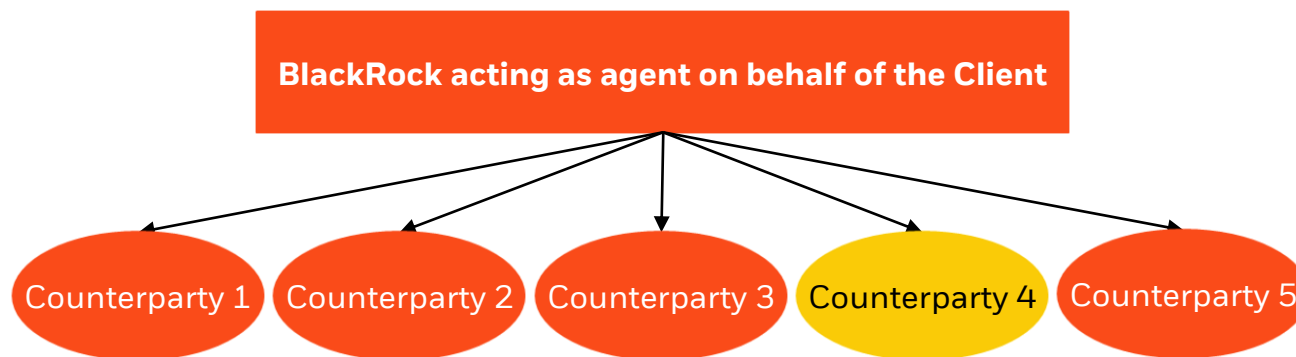
Transx Type	Unbooked Amt	Ticker	Mkt Opty	Opportunity	Asset ID
BUY	800,000		GS		1110
BUY	500,000		SMRD	Merge	1729
BUY	50,000				4592
SELL	-2,000,000				1430
SELL	-525,000		SMRD		2524
BUY	1,187,000				7432
BUY	500,000		SMRD	Cross	2681
BUY	1,885,000				2688
BUY	2,000,000				3696
SELL	-300,000		SMRD		4410
BUY	2,500,000				4498
SELL	-130,000			Cross	4567
BUY	3,400,000				4711

Clients leverage BlackRock's purchasing power

Source: BlackRock as of February 28, 2022
Screenshot for illustrative purposes only

Foreign Exchange (FX) Process

- All FX transactions are executed as agent
- Range of execution techniques available; selection is driven by tailored trading strategy
- Access to electronic trading platforms and execution algorithms
- Competitive bidding process
- No selection bias



Transparent agency process ensures low costs and no hidden revenues on FX

Transition Transparency Tool

	Your Transition Manager	BlackRock Transition Manager
Do you earn revenue by internal crossing?	?	No
Do you earn revenue from sales trading activity?	?	No
Do you earn revenue by acting in a principal capacity?	?	No
Do you capture a spread on fixed income within your affiliated broker dealer?	?	No
Do you capture a spread on fixed income commission based on basis points of yield rather than market value?	?	No
Do you earn revenue from mark up/down of fixed income trades?	?	No
Do you earn revenue by trading futures?	?	No
Do you earn revenue from an affiliate who acts in a principal capacity?	?	No
Do you earn revenue from order-flow payment or participate in soft-dollar arrangements?	?	No
TOTAL HIDDEN REVENUE:	?	\$0

Transparency and Revenue Disclosure

- BlackRock believes that revenue transparency is crucial to a successful transition management business model and is an important factor in selecting a Transition Manager. The only compensation, direct or indirect, we receive is captured either within the commissions paid in connection with transition assignments or through a flat fee agreed upon in advance of the transition. BlackRock will act as a fiduciary on behalf of its transition clients and has a transparent, agency-based commission compensation model. BlackRock earns transition commissions associated with trades processed through its agency affiliate, BlackRock Execution Services and we are willing to fully disclose these commissions in writing.
- Neither BlackRock nor its affiliates receive any revenue other than what is explicitly quoted in our pre and post trade reporting as a fee or commission received in connection with executing transition trades requested by our clients.
- BlackRock has developed a transition transparency report card to help plan sponsors uncover hidden revenue within the transition process. As shown below, we are committed to full transparency and earn no hidden revenue on the transitions we execute.

Our Competitive Advantages

Investment manager operating model

- Full fiduciary oversight – ability to act as sub-advisor
- All transactions executed as agent with full transparency on price discovery and fees
- No sell side conflicts – all orders treated fairly
- Competitive fees while offering access to multiple counterparties and liquidity venues

Significant experience managing complex multi-asset class transitions

- Managed approximately \$469B* in transitions annually over the past 5 years
- Diverse client base: Pension (DB and DC), Endowment, Sovereigns and 40 Act funds
- BlackRock Transition Management has expertise with all global publicly traded asset classes
- Active risk management using futures, ETFs, and Treasuries

Extensive access to liquidity

- Large global trading platform supporting \$10T AUM**
- Direct access to over 150 person trading team
- Significant internal liquidity via crossing and indications of interest (IOI)
- Unique advantages of being a large client of the street vs. a competitor

*Refers to round trip value of assets transitioned 2017 - 2021 **As of December 31, 2021

Our Competitive Advantages (continued)

Robust investment technology and risk analytics

- Manage all assignments on Aladdin®, our market leading enterprise investment platform
- Sophisticated multi-asset class risk models and analytics (*Portfolio Risk Tools*)
- Ability to run a wide variety of scenario analyses to support decision making process
- Dedicated Trade Analytics Research (TAR) team to measure trade costs and select counterparties and venues
- DOL regulated internal crossing system

Comprehensive project management support

- Highly experienced transition management team
- 60+ person dedicated global team with 22 staff in U.S.*
- Disciplined and formal process for managing all aspects of a transition
- Open and frequent communication during the transition process
- Full support of middle and back office to minimize operational risk

*As of September 2022

Important Notes

BlackRock Institutional Trust Company, N.A. (“BTC”) offers transition services to both its investment management clients and third party clients. Such transition services usually include brokerage services through its wholly owned subsidiary, BlackRock Execution Services (“BES”), member FINRA. BES receives commissions from the Client for trades that BES executes in the course of transitions services. BES itself purchases clearing or other brokerage services from third parties and/or affiliates with some or all of the commission that BES receives.

The information contained herein is proprietary in nature and has been provided to you on a confidential basis, and may not be reproduced, copied or distributed without the prior consent of BTC.

BTC does not provide investment advice regarding any security, manager or market. The information contained in this document is not intended to provide investment advice. BTC does not guarantee the suitability or potential value of any particular investment. Transition portfolios may be difficult to trade in adverse market conditions, and in the event of such market conditions, securities prices and volume can be expected to be quite volatile and transaction and market impact costs may be higher than anticipated. In addition, BTC’s use of certain strategies may be affected by government or regulatory restrictions.

These materials are being provided for informational purposes only, and are not intended to constitute tax, legal or accounting advice. You should consult your own advisers on such matters. Additional information is available on request. Information contained herein is believed to be reliable but BTC does not warrant its accuracy or completeness. The opinions expressed are as of September 2022 and may change as subsequent conditions vary. The information and opinions contained in this material are derived from proprietary and nonproprietary sources deemed by BlackRock to be reliable, are not necessarily all-inclusive and are not guaranteed as to accuracy. There is no guarantee that any forecasts made will come to pass. These materials are neither an offer to sell, nor a solicitation of any offer to buy, shares in any fund.

Certain information contained in this document constitutes “forward-looking statements,” which can be identified by the use of forward-looking terminology such as “may”, “will”, “should”, “expect”, “anticipate”, “target”, “project”, “estimate”, “intend”, “continue” or “believe” or the negatives thereof or other variations thereon or comparable terminology. Due to various risks and uncertainties, actual events or results or the actual performance of the portfolio may differ materially from those reflected or contemplated in such forward-looking statements.

Important Notes

In the U.S., this material is intended for institutional investors only - not for public distribution

In Canada, this material is intended for institutional investors only, is for educational purposes only, does not constitute investment advice and should not be construed as a solicitation or offering of units of any fund or other security in any jurisdiction.

In Mexico, for institutional and qualified investor use only. Investing involves risk, including possible loss of principal. This material is provided for educational and informational purposes only and does not constitute an offer or solicitation to sell or a solicitation of an offer to buy any shares of any fund or security.

This information does not consider the investment objectives, risk tolerance or the financial circumstances of any specific investor. This information does not replace the obligation of financial advisor to apply his/her best judgment in making investment decisions or investment recommendations. It is your responsibility to inform yourself of, and to observe, all applicable laws and regulations of Mexico. If any funds, securities or investment strategies are mentioned or inferred in this material, such funds, securities or strategies have not been registered with the Mexican National Banking and Securities Commission (Comisión Nacional Bancaria y de Valores, the "CNBV") and thus, may not be publicly offered in Mexico. The CNBV has not confirmed the accuracy of any information contained herein. The provision of investment management and investment advisory services ("Investment Services") is a regulated activity in Mexico, subject to strict rules, and performed under the supervision of the CNBV. These materials are shared for information purposes only, do not constitute investment advice, and are being shared in the understanding that the addressee is an Institutional or Qualified investor as defined under Mexican Securities (*Ley del Mercado de Valores*). Each potential investor shall make its own investment decision based on their own analysis of the available information. Please note that by receiving these materials, it shall be construed as a representation by the receiver that it is an Institutional or Qualified investor as defined under Mexican law. BlackRock México Operadora, S.A. de C.V., Sociedad Operadora de Fondos de Inversión ("BlackRock México Operadora") is a Mexican subsidiary of BlackRock, Inc., authorized by the CNBV as a Mutual Fund Manager (Operadora de Fondos), and as such, authorized to manage Mexican mutual funds, ETFs and provide Investment Advisory Services. For more information on the Investment Services offered by BlackRock Mexico, please review our Investment Services Guide available in www.blackrock.com/mx. This material represents an assessment at a specific time and its information should not be relied upon by you as research or investment advice regarding the funds, any security or investment strategy in particular. Reliance upon information in this material is at your sole discretion. BlackRock México is not authorized to receive deposits, carry out intermediation activities, or act as a broker dealer, or bank in Mexico. For more information on BlackRock México, please visit: www.blackRock.com/mx. BlackRock receives revenue in the form of advisory fees for our advisory services and management fees for our mutual funds, exchange traded funds and collective investment trusts. Any modification, change, distribution or inadequate use of information of this document is not responsibility of BlackRock or any of its affiliates. Pursuant to the Mexican Data Privacy Law (Ley Federal de Protección de Datos Personales en Posesión de Particulares), to register your personal data you must confirm that you have read and understood the Privacy Notice of BlackRock México Operadora. For the full disclosure, please visit www.blackRock.com/mx and accept that your personal information will be managed according with the terms and conditions set forth therein.

©2022 BlackRock, Inc. All rights reserved. ALADDIN, iSHARES and BLACKROCK are trademarks of BlackRock, Inc., or its subsidiaries in the United States and elsewhere. All other marks are the property of their respective owners.

Markets and Securities Services



November 3, 2022

Citi Global Transition Management

Presentation prepared for:

Los Angeles City Employees' Retirement System

William Cobbett, CFA, FRM

Managing Director

Head of Transition Management

william.g.cobbett@citi.com

+1 212 723 4181



TEAM: CITITM@CITI.COM

Key professionals working on the LACERS account



Will Cobbett, Managing Director, Head of Americas Transition Management

Will joined Citigroup Global Transition Management in July 2006. Prior to joining Citigroup, Will was a Partner at Montreal based investment boutique Pavilion Global Markets Ltd. (formerly Brockhouse Cooper) in their Transition Management department. Prior to working in transition management Will worked on the North American and the European equity program trading teams at Brockhouse Cooper. Will holds a post-graduate Diploma in Business Studies from the London School of Economics and a B.A. from Huron College at the University of Western Ontario. He is a CFA Institute member and earned the Chartered Financial Analyst designation in 2004. He is also a member of General Association of Risk Professionals (GARP) and earned Financial Risk Manager designation in November 2005. FINRA qualification exams Series 63, SIE, Series 3, Series 7, Series 37, and Series 24.



Jerome Hogan, Vice President, Project Manager

Jerome joined Citi in May 2019 and is a Project Manager on the US transition team, responsible for trade analysis, strategy, and business development. Prior to joining Citi Jerome worked for Macquarie Capital in New York and Russell Investments for 14 years in Sydney in their respective Transition Management departments. He graduated from University College Dublin with a Masters in Economics and from Macquarie University Sydney with a Masters in Applied Finance. Jerome has passed the Series 7, Series 63 and SIE exams.



Patrick Roth, Assistant Vice President, Project Manager

Patrick came to the TM team through the Citi Analyst Program and was previously on the Equity Sales Trading desk focusing on Asia Pacific long only clients. Patrick began his career at Citi in 2012 in middle office where he oversaw daily functions supporting clients and sales traders on the Cash, Convertible Bond, ETF, Electronic, Portfolio, Delta One, and TM desks. Patrick is a graduate of Niagara University with a BS and MBA in Finance. Since working at Citi, Patrick has passed the Series 3, 7, 57, 63 and SIE.



Perry – King Tita, Analyst

Perry came to the TM team through the Citi Markets Analyst rotational program. Prior to joining the team, Perry worked on the Global Transactional FX team, and interned across FX and Rates. Perry graduated from the University of Pennsylvania with the BA in Economics. Perry has passed the series 7, Series 63 and SIE exams.

TM overview as at Sep 30th

Total Transitions

Year	Number of Transitions	Total Market Value (round-trip) (\$ millions)
YTD - Sept 30th 2022	953	529,095

Total U.S. Equities Transitions

Year	Number of Transitions	Total Market Value (round-trip) (\$ millions)
YTD - Sept 30th 2022	313	240,512

Total Global Developed Markets Equities Transitions

Year	Number of Transitions	Total Market Value (round-trip) (\$ millions)
YTD - Sept 30th 2022	305	196,903

Total Emerging/Frontier Markets Equities Transitions

Year	Number of Transitions	Total Market Value (round-trip) (\$ millions)
YTD - Sept 30th 2022	203	8,920

Total Fixed Income (including U.S. and Global) Transitions

Year	Number of Transitions	Total Market Value (round-trip) (\$ millions)
YTD - Sept 30th 2022	134	82,760

Organizational Vision and Business Approach

- Citigroup's Vision and Value Proposition is to serve as a trusted partner to our clients by responsibly providing financial services that enable growth and economic progress. Our core activities are safeguarding assets, lending money, making payments, and accessing the capital markets on behalf of our clients. We have 200 years of experience helping our clients meet the world's toughest challenges and embrace its greatest opportunities. We are Citi, the global bank – an institution connecting millions of people across hundreds of countries and cities.
- We protect people's savings and help them make the purchases – from everyday transactions to buying a home – that improve the quality of their lives. We advise people on how to invest for future needs, such as their children's education and their own retirement, and help them buy securities such as stocks and bonds.
- We work with companies to optimize their daily operations, whether they need working capital, to make payroll, or export their goods overseas. By lending to companies large and small, we help them grow, creating jobs and real economic value at home and in communities around the world.
- We provide financing and support to governments at all levels, so they can build sustainable infrastructure, such as housing, transportation, schools, and other vital public works.
- These capabilities create an obligation to act responsibly, do everything possible to create the best outcomes, and prudently manage risk. If we fall short, we will take decisive action and learn from our experience.
- We strive to earn and maintain the public's trust by constantly adhering to the highest ethical standards. We ask our colleagues to ensure that their decisions pass three tests: they are in our clients' interests, create economic value, and are always systemically responsible. When we do these things well, we make a positive financial and social impact in the communities we serve and show what a global bank can do.

Organizational Structure

Five Interconnected Core Businesses



Services

Treasury & Trade Solutions (#1)
 Securities Services (#4)

- Drives network value
- \$300+ billion wallet; sticky relationships
- Invest for continued leadership; grow with new client segments

Markets

Markets (#4)
 Fixed Income (#2)
 Equities (#5)

- Maintain leadership in FICC; continue to grow Equities
- Emphasize profitability
- Maximize linkages across ICG

Banking

Investment Banking (#5)
 Corporate Banking
 Commercial Banking

- High-returning, capital-light Investment Banking business; elite Corporate Bank
- Extend growth momentum with focus on new economy companies
- Grow the Commercial Bank

Global Wealth Management

Citi Private Bank (#5)
 Wealth Management (#3 in Asia)

- Strong foundation; differentiated international business
- Leverage existing leadership position in the Private Bank and Asia Wealth
- Scale to focus on full wealth spectrum

U.S. Personal Banking

Branded Cards (#2 in U.S.)
 Retail Services
 Retail Banking

- Refocused strategy
- Serves 72 million customers
- Affluent retail clients that feed Wealth business

For a reconciliation of rankings see slides 22-23 of Jane Fraser's 2022 Investor Day presentation:
<https://www.citigroup.com/citi/investor/investor-day/2022/data/ID22-CEO-Presentation.pdf>

© 2022 Citigroup Inc. Citi, Citi and Arc Design and other marks used herein are service marks of Citigroup Inc. or its affiliates, used and registered throughout the world.
 2081365 03/22

Citi's Transition Management business sits with **Markets**

How We Do Business – Our Transition Management Philosophy

Our overall goal in any transition is to truly partner with our clients – to understand *their* goals and make those goals a reality

No two transitions are alike, just as no two clients are alike

- Citi believes close communication, and a two-way dialogue is the key to a successful event.
- We never take on too many projects at once, so that we can ensure availability and focus.
- Rather than becoming an assembly line, we prefer to work with larger, more sophisticated clients on more difficult events, offering tailored plans and solutions.
- We hear time and again that Citi's service and level of communication are second-to-none.



How We Do Business – Our Process

Transitions are complex events – all pieces of the puzzle must fit together in order to achieve a successful result

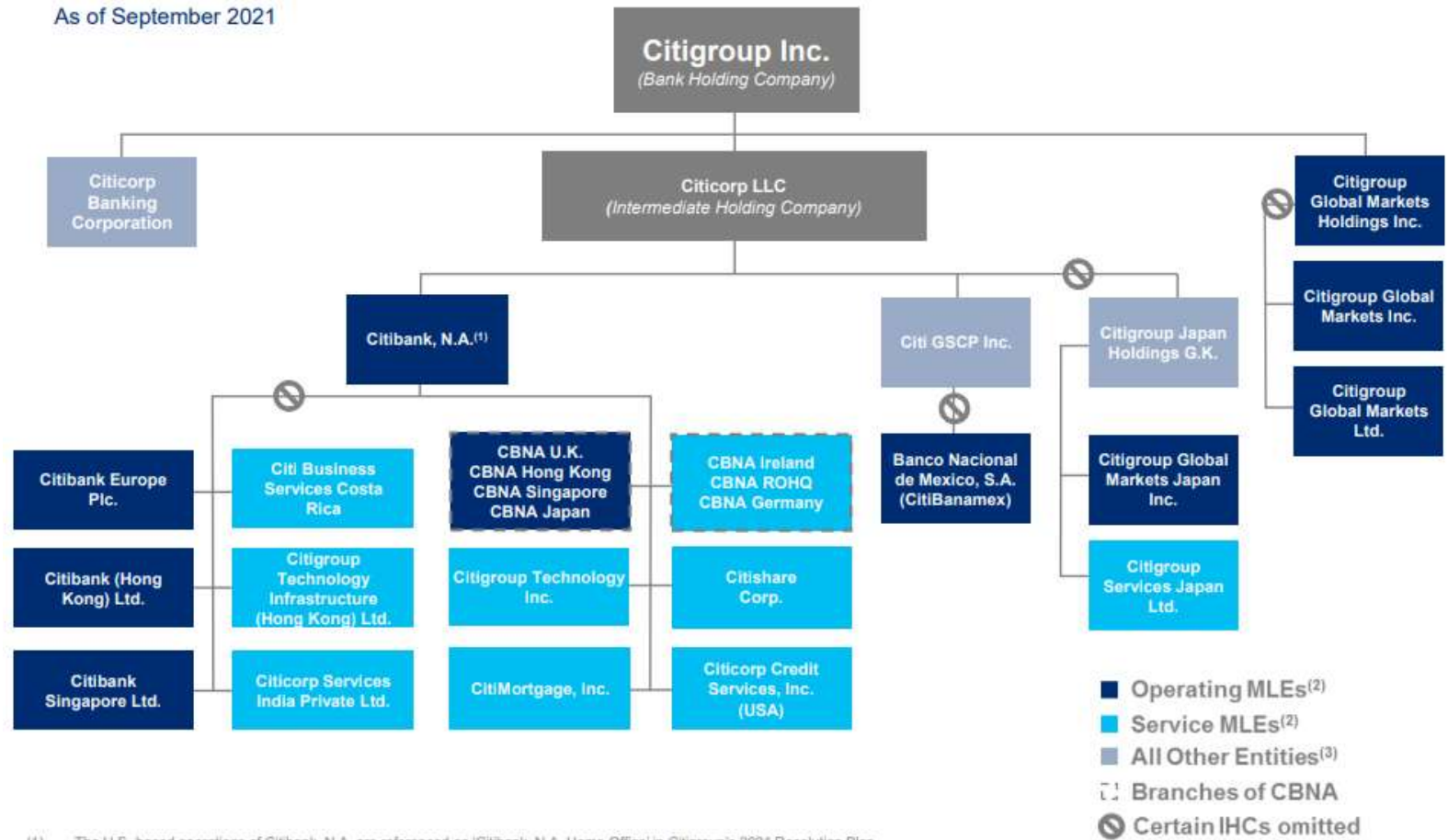
Our process goes hand-in-hand with our philosophy

- Gather information in order to understand your goals
- Develop a project plan which covers all aspects of operations and clearly identifies each party's responsibilities
- Create a strategy for execution which at all times reduces risk and minimizes cost
- Implement that strategy using all the firm's cutting-edge tools
- Communicate throughout the process with the client to guarantee understanding and avoid surprises
- Report with complete transparency on a pre, intra and post transition basis



Ownership Structure

Citigroup Global Markets Inc. is a wholly owned subsidiary of Citigroup Financial Products Inc. The ultimate parent company is Citigroup Inc. (Ticker C)

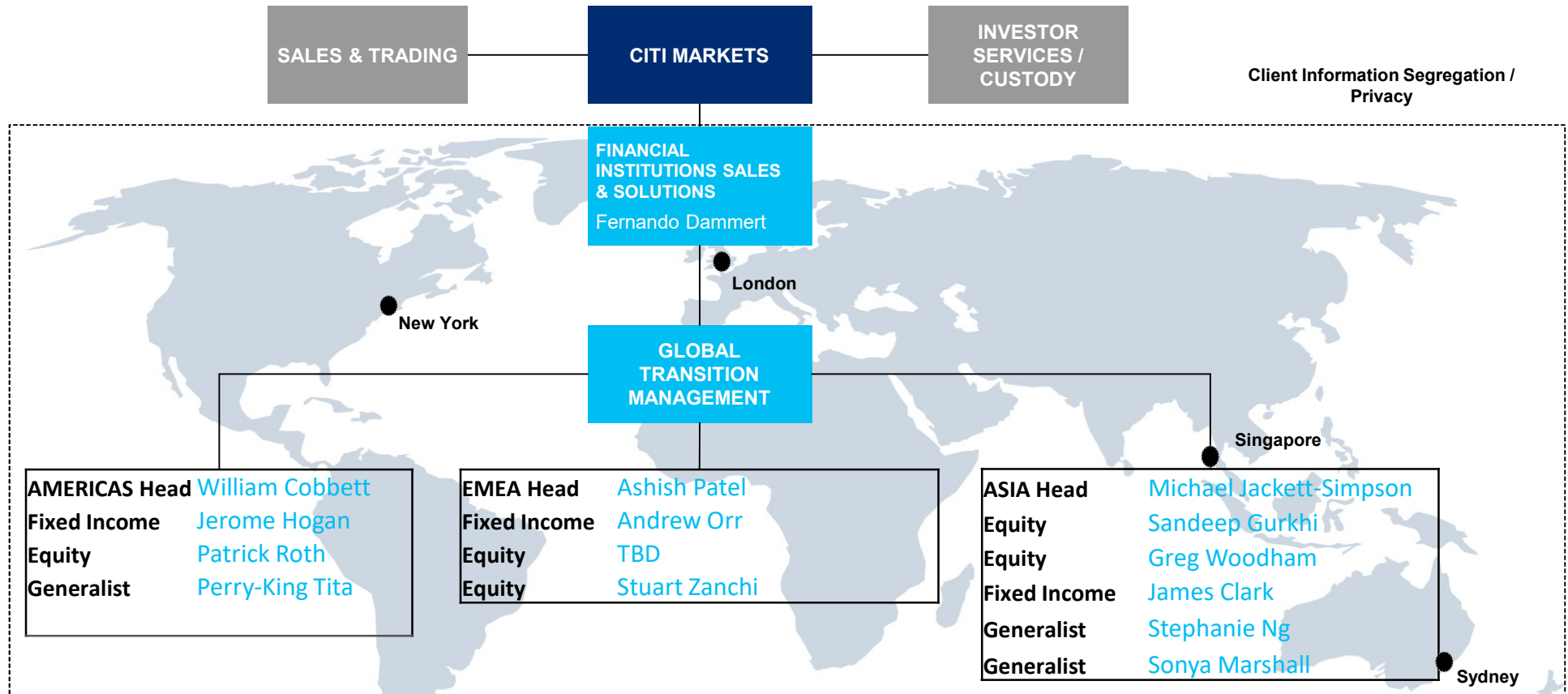


(1) The U.S.-based operations of Citibank, N.A. are referenced as 'Citibank, N.A. Home Office' in Citigroup's 2021 Resolution Plan
 (2) Represents material legal entities (MLEs) as defined by the 165(d) Rule under the Dodd-Frank Act, which specifies that an MLE is an entity, including a subsidiary or foreign office, that is significant to the activities of a core business line (CBL) or critical operation (CO). Material legal entities reported under the Dodd-Frank Act may differ from the significant legal entity subsidiaries as reported in Citi's SEC filings.
 (3) Represents intermediate holding companies not identified as MLEs in Citigroup's 2021 Resolution Plan, included to illustrate Citi's organizational structure



Global TM Project Coverage

CitiTM has been delivering integrated portfolio solutions for over 25 years while servicing global clients from 3 locations.

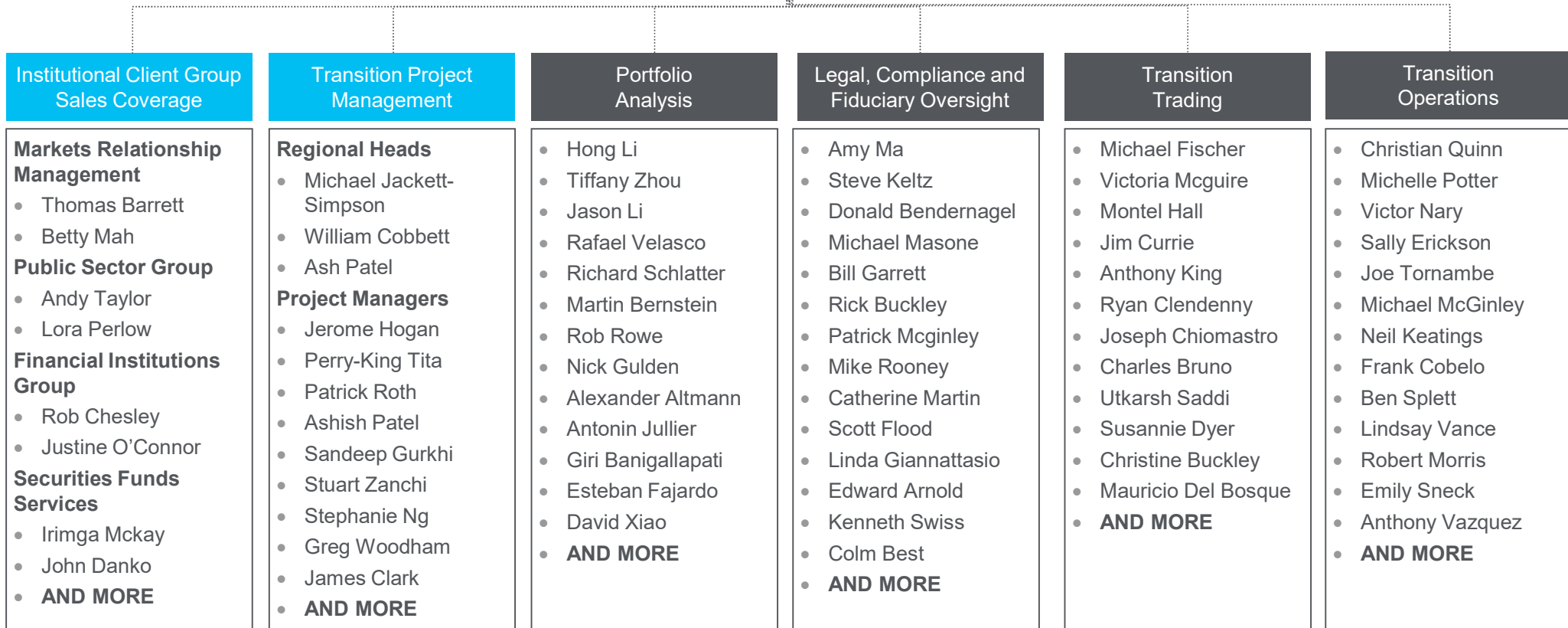


CitiTM consists of 15 project managers. The Global TM team delivers:

- Seamless service by integrating Citi infrastructure across the global team.
- Immediate access to all pre and post transition data globally.
- Continuity of service through transferable knowledge and experience between teams, and regular communication.
- 24-hour global coverage of client projects.
- Support of the wider Citi franchise including legal, compliance, trading, settlements and risk solutions teams (240 people).

Members of the operations and administrative support staff

The dedicated team leverages a network of thousands of experts around the globe – through this structure, we can deliver small-team customer service along with unparalleled resources and expertise.



Our People – Staffing and Mentoring

Citi runs a thriving talent development program for both summer interns and a 2-year analyst rotation initiative

Citi Transition Management is an active participant in the Markets and Securities Services Analyst Rotation Program, and is dedicated to mentoring and development activities

- Citi is dedicated to building its future with recent graduates from top tier 1 universities and colleges. Every summer Citi hires approximately 100 analysts to a rigorous two-year analyst rotation program. Analysts complete two one-year rotations on various desks within the Markets and Securities division.
- Analysts are assigned senior and junior mentors during their rotation. Will Cobbett on the Transition Management team is an active mentor helping coach new analysts through the program.
- Analysts are measured based on performance, it is only after the Desk Head, is comfortable with the analyst's progression that they are given more responsibility involving various aspects of a transition. Analysts will then help assist the team perform transitions with close diligent oversight from senior members.
- Following the two-year rotation, analysts interview with senior members of the bank for a full-time associate placement within the firm.
- Transition Management has participated in the program since 2011 and thus far has a 100% success rate of analysts on our team getting full-time associate offers.

The Importance of Transition Management to Citi

Citi Transition Management stands out in clear and important ways

Citi's strengths come from the expertise of our people and the unmatched capabilities of the firm

- **A conduit into Pension Fund Clients** – The Institutional Clients Group sees Pension Funds as important prospects. Transition Management is part of the suite of services the firm needs to be valuable partners to this section of the client base.
- **Clean and sizeable flow** – Transitions tend to be large events and bring liquidity to the firm which enhances our overall profitability and leads to additional flow.
- **Commissions earned** – Transition Management brings in commission dollars without taking risk or balance sheet. As we leverage many existing systems, the overhead for the group is low.

Given the importance of the product within the context of Citi's Institutional Clients Group, the TM team receives senior support and resources

- **Head count available** – Even in the current environment of cost cutting, the TM team has been allocated resources to add staff when and where necessary.
- **Senior presence and awareness** – Citi management at the highest levels have expressed support and gone on record to indicate the firm's commitment to the business. Seniors are available for calls and meetings with TM clients.
- **Compensation Structure** – Citi TM team members are compensated via a base salary and discretionary bonus. Team members are evaluated on individual, team, business unit and overall firm performance.

Market Share and Growth Potential

Citi has seen significant growth over the last 5 years by focusing on doing larger events for more sophisticated clients

Citi is optimistic about growth potential, but insists such growth be organic and in-line with our philosophy:

- **Volume and revenue growth** – Citi will continue to work with the largest clients on a limited number of larger events rather than greatly increasing the number of events.
- **Team growth** – In keeping with our focus on larger events and more sophisticated clients, Citi sees moderate growth in team size over the next 1-3 years. As more resources are needed, we have the ability to add, but we prefer to maintain our smaller teams working closely with clients.
- **Technology enhancements** – We will continue to make investments in our Transition Management System, Smart Order Routing, BECS analytics and reporting systems.
- **Pension Funds** - Finally, Citi has made the decision to focus in a more coordinated way on servicing our pension fund clients. In many cases, the firm's best relationship with the larger corporate and public pension funds resides within the transition management group. Those relationships can provide an entry for other products into the pension fund and help build the firm's overall relationship with these key clients. We believe this model will be mutually beneficial to Citi and our pension fund clients – clients will benefit from the streamlined sales approach, and the one-stop shopping aspect, and Citi will benefit from the opportunity to generate revenue from the additional products used.

Best Execution

Citi's Best Execution Policy

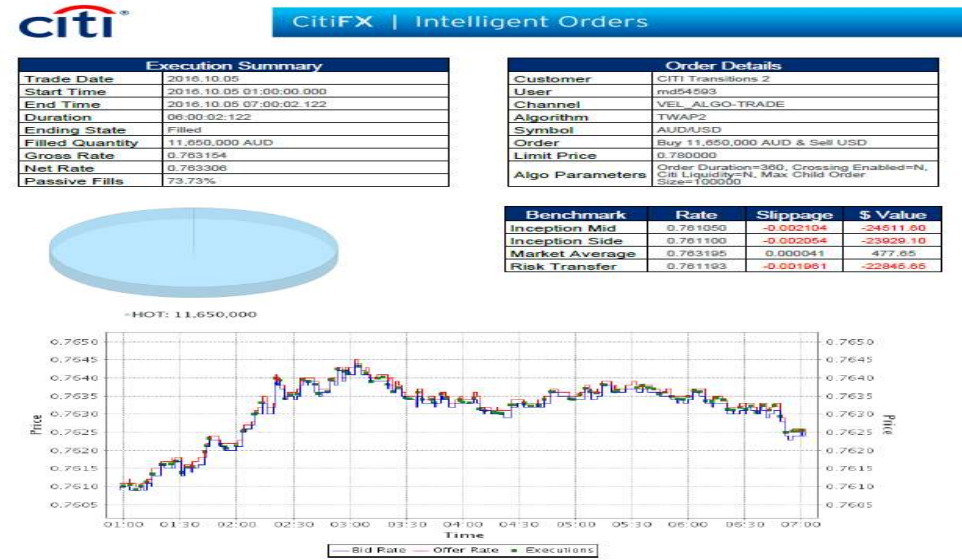
Best execution means the requirement to take all sufficient steps to obtain the best possible result for clients, taking into account price, costs, speed, likelihood of execution and settlement, size, nature or any other consideration relevant to the execution of an order. These execution factors provide the basis for us to explain how we provide best execution. We must use reasonable diligence to ascertain the best market for the subject security and buy or sell in such market so that the resultant price to the transition client is as favorable as possible under prevailing market conditions and the terms and conditions of the customer's inquiry or order.

- The definition of "reasonable diligence" for a particular transaction is based on facts and circumstances, including:
 - the character of the market for the security (e.g., price, volatility, relative liquidity).
 - the size and type of transaction.
 - the number of markets checked.
 - the information reviewed to determine the current market for the subject security or similar securities; and accessibility of quotations.
- The definition of "market" is any venue in which the type of securities are traded, including securities exchanges, alternative trading systems or platforms, brokers' brokers, and other counterparties (which may include Citi itself when acting as principal).
- We will provide best execution when we are executing an order on the plan's behalf or receiving and transmitting an order. Best execution applies when we act as agent for our clients, or where we trade with clients on a riskless or matched principal basis, it is generally clear that clients will be relying on us to protect their interests and therefore we will provide best execution.

Best Execution Verification

Citi provides clients with full transparency through child prints which allow a third party to review and evaluate trading

- Citi can demonstrate best execution by showing securities were traded at the best available price at the time of execution given the all-encompassing transition goal. To show this child prints are available upon request for Equity and FX executions.
 - All Equity and FX child prints have a time stamp and indicate the venue or exchange it was traded on.
 - Fixed Income executions include the cover(s).
- Fixed income trades done on a principal basis are executed on an agreed upon spread vs benchmark prices ensuring transparent price discovery.
- Sophisticated proprietary Smart-routers access alternative execution venues in the US and overseas. Our ability to efficiently access these rapidly growing sources of liquidity far surpasses that of our competition. Our Smart Routing technology is “cost no object” with decisions about venue made solely on the quality of execution.



Citi Equity | Child Prints

LIST	RIC	SEDOL	SIDE	EXEC_QUANTITY	EXEC_PRICE	EXCHANGE	TRADE_DATE	EXEC_TIME_GMT
TRA0217_05	2330.TW	6889106	S	7000	190.5	TAIP	2/22/2017	01:00:03:350
TRA0217_05	2330.TW	6889106	S	1000	190.5	TAIP	2/22/2017	01:03:16:366
TRA0217_05	2330.TW	6889106	S	6000	190.5	TAIP	2/22/2017	01:16:30:300
TRA0217_05	2330.TW	6889106	S	7000	190	TAIP	2/22/2017	01:31:37:443



Competitive Advantages

Citi versus our competitors

Operating from within Citi's Markets and Security Services business allows us to provide unrivalled access to global capital markets on behalf of transition clients. Citi's ability to draw on the best attributes of a leading global investment bank and one of the world's largest global custody banks is what most clearly distinguishes us from the competition. This model allows us to provide lower commission rates yet be more profitable than competitors that rely on other firms to trade and/or settle transactions.

The following are what we see to be our greatest competitive advantages:

- **Experience and Trust** – The transition management team at Citi is comprised of seasoned professionals with a lot of industry experience. Our team has managed thousands of transactions and brings a wealth of transition acumen to each engagement.
- **Un-conflicted independent transition management model** – Citi partners with our clients, offering transparency at every stage which far exceeds that of the competition.
- **Seamless project management** – Citi has developed an in-house proprietary transition management system. All details of a transition are maintained electronically in a robust, comprehensive platform. Data are communicated electronically with all counterparties, thus reducing the potential for error across the business.
- **Operational control and efficiency** – The seamless project management coupled with the Citi custodial architecture provides unmatched operational processing and reconciliation.
- **Proven risk management** – Clients worldwide come to Citi for sophisticated risk control tools and trading. We understand risk and have developed systems and procedures to mitigate it for our customers. As implicit costs far outweigh explicit costs in a transition, risk control is key.

Competitive Advantages.. continued

Citi versus our competitors

The following are what we see to be our greatest competitive advantages:

- **Meaningful transaction cost estimates** – How well cost estimates match actual results varies widely among transition managers. Citi believes cost forecast accuracy is a crucial part of the transition management product. Citi utilizes sophisticated forecasting tools like BECS to provide realistic transaction cost estimates which are never spun down to win a deal.
- **Global, direct multi-asset execution expertise** – Trading is at the core of every transition. Citi is a world leader in global execution of nearly every instrument in more markets than any other firm. The importance of low cost, risk-controlled execution should not be undervalued. Many transition managers have little trading capability and out-source execution which leads to additional layers of cost, information slippage and inferior results.
- **Product expertise to add value in every transaction** – Unlike many transition managers, Citi is an important execution counterparty for the most sophisticated investment managers in the world across all asset classes and products. The largest asset managers use trading counterparties who add the most value to their execution. Asset owners can gain the same benefits when selecting Citi as their transition manager.
- **Natural liquidity and distribution** - Our ability to efficiently access rapidly growing sources of liquidity far surpasses that of our competition. Our Smart Routing technology is “cost no object” with decisions about venue made solely on the quality of execution.
- **Ability to deliver flexible transition solutions** – Citi offers flexible transition solutions ranging from straight agency market transactions to structured vehicles customized to the exact specifications of a client. Citi has the product knowledge and experience to deliver creative alternatives that can save asset owners money during restructurings. Unlike many competitors, we are not limited by our model, and can focus on the needs of our clients.
- **Accountability and transparency** – Citi calls it like we see it. We compare total costs to estimates and explain any variance, positive or negative. We analyze what went right and what went wrong, what was controllable and what was seemingly random. Every trade and every dollar will be accounted for, giving the client a detailed accounting of the entire restructuring process. Citi is also the only transition manager to show name-by-name crossing details on both a pre and post trade basis.

CitiVELOCITY™ - Transaction Cost Modelling

Citi transaction costs analysis tool, BECS, is available online to our clients. This allows our clients to evaluate costs on their own and importantly, assures clients that our estimates are meaningful and never scaled down to win mandates.

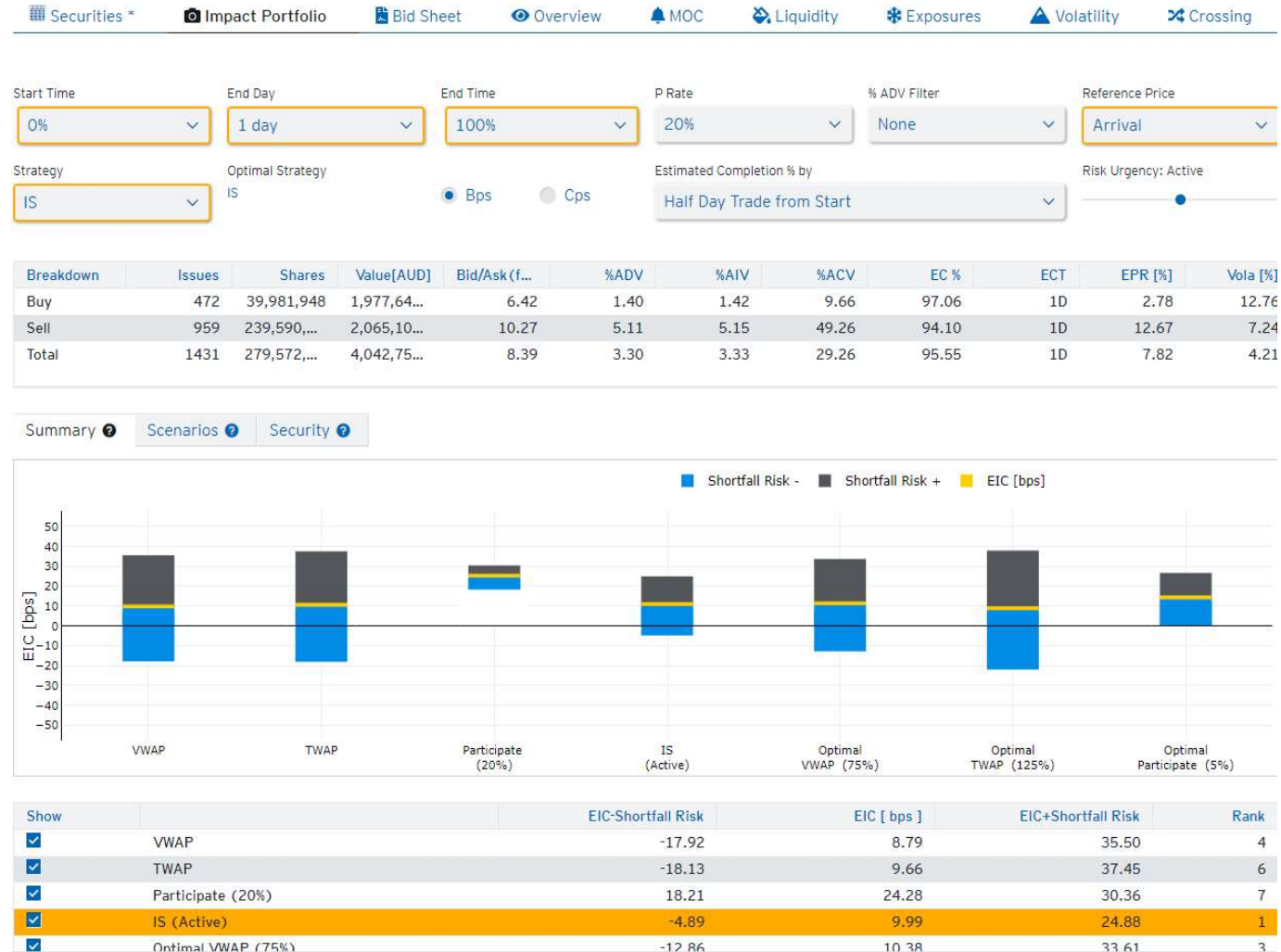
BECS (Best Execution Consulting Services)

Transition clients frequently utilize BECS, the equity transaction cost modelling function within Citi Velocity, to model the optimal strategy to execute and the expected cost for a any given transition. BECS shows total cost estimates as the function of participation rate (market impact cost) and speed of execution (opportunity cost).

This is the same transaction cost model that Citi TM uses for its equity pre-trades. In addition to being used by clients, it is also often used as an additional resource to estimate implicit cost by other transition providers.

BECS utilizes real trade information taken directly from our extensive databases to provide realistic transaction costs estimates and optimal strategies.

- Spreads: BECS relies on the data from the last 60 days, less highest and lowest 10-day average of intraday spreads.
- Volatility: BECS uses 10-day intraday realized volatility



CitiVELOCITY™ - Market Commentary and Insights

Citi Velocity is the award-winning digital platform for Markets, Securities Services & Banking, Capital Markets and Advisory Clients

Commentary and Insights

Combining Citi's global footprint with world-class innovation, Citi Velocity provides unparalleled access to cross-asset Research, trading desk commentary, proprietary data, analytics, exclusive videos, webcasts and more to empower our clients to make the most informed investment decisions.

The screenshot displays the CitiVELOCITY web application interface. At the top, there is a navigation bar with the CitiVELOCITY logo, a 'Browse' button, and links for Home, My Citi Velocity, Recent, Favorites, Analytics, and Suggested. A search bar is located on the right. Below the navigation bar, the page is titled 'Home / Market Buzz'. A list of recent posts is shown, including 'Iranian diplomats arrive in Saudi to take up Organisation of Islamic Cooperation posts' and 'Five things to know about Credit Suisse's new chairman Lehmann'. The main content area is titled 'VIDEO CENTER' and features five video thumbnails with speaker portraits and titles:

- Daniel Buntardjo**: IDR FX/Rates: Watching Not So Favourable Seasonali... (17 Jan 2022 02:04)
- Ayso Van Eysinga**: Citi CEEMEA Frontier Credit: Tough Start to Q1 (14 Jan 2022 11:30)
- Mohammed Apabhai**: Change in Regime for 2022: Dr. Mo's Take (13 Jan 2022 19:06)
- Tim Evans**: US Natural Gas: Bullish for Now (13 Jan 2022 18:40)
- Tim Evans**: US Gasoline: Market's Achi... (13 Jan 2022 18:40)

Below the video center, there are sections for 'POPULAR' and 'TRENDING' content. The 'POPULAR' section includes:

- Edward Acton** (14 Jan 2022 14:40 EST): Trade Idea: US Rates at the Bell January 14th 2022 [CFTC Swap Trade Idea]. Top Links: Fed's Williams Says Decision on Rate Increases 'Approaching' (BBG), Fed's Daly: COVID-19 caused inflation, but Fed has to fix it (Rtrs), German economy shrinks.
- US Rates Corner** (14 Jan 2022 07:27 EST): Trade Idea: US Rates Reveille January 13, 2022 [CFTC swap trade idea]. > US News: Biden nominated Sarah Bloom Raskin to be the Fed's top banking regulator and economists Lisa Cook and Philip Jefferson to be governors BBG Surqing Omicron.
- Tom Fitzpatrick** (13 Jan 2022 12:38 EST): IF The Shoe FITZ: The Charts To Watch.

The 'TRENDING' section includes:

- Adrian Lemme, CFA** (16 Jan 2022 22:27 EST): Wesfarmers Ltd (WES.AX): Overall inline though compositionally different.
- Johanna Chua** (16 Jan 2022 22:21 EST): Asia Economics & Strategy Daily: PBoC Cuts Rate.
- Stephen Trent** (16 Jan 2022 18:59 EST): Delta Air Lines, Inc (DAL.N): Near-term headwinds likely limit upside in Jan. and Feb.
- Nathan Sheets** (14 Jan 2022 17:27 EST): Global Economics: Global Supply Chain Disruptions.

IRS Circular 230 Disclosure: Citigroup Inc. and its affiliates do not provide tax or legal advice. Any discussion of tax matters in these materials (i) is not intended or written to be used, and cannot be used or relied upon, by you for the purpose of avoiding any tax penalties and (ii) may have been written in connection with the "promotion or marketing" of any transaction contemplated hereby ("Transaction"). Accordingly, you should seek advice based on your particular circumstances from an independent tax advisor.

In any instance where distribution of this communication is subject to the rules of the US Commodity Futures Trading Commission ("CFTC"), this communication constitutes an invitation to consider entering into a derivatives transaction under U.S. CFTC Regulations §§ 1.71 and 23.605, where applicable, but is not a binding offer to buy/sell any financial instrument.

Any terms set forth herein are intended for discussion purposes only and are subject to the final terms as set forth in separate definitive written agreements. This presentation is not a commitment to lend, syndicate a financing, underwrite or purchase securities, or commit capital nor does it obligate us to enter into such a commitment, nor are we acting as a fiduciary to you. By accepting this presentation, subject to applicable law or regulation, you agree to keep confidential the information contained herein and the existence of and proposed terms for any Transaction.

Prior to entering into any Transaction, you should determine, without reliance upon us or our affiliates, the economic risks and merits (and independently determine that you are able to assume these risks) as well as the legal, tax and accounting characterizations and consequences of any such Transaction. In this regard, by accepting this presentation, you acknowledge that (a) we are not in the business of providing (and you are not relying on us for) legal, tax or accounting advice, (b) there may be legal, tax or accounting risks associated with any Transaction, (c) you should receive (and rely on) separate and qualified legal, tax and accounting advice and (d) you should apprise senior management in your organization as to such legal, tax and accounting advice (and any risks associated with any Transaction) and our disclaimer as to these matters. By acceptance of these materials, you and we hereby agree that from the commencement of discussions with respect to any Transaction, and notwithstanding any other provision in this presentation, we hereby confirm that no participant in any Transaction shall be limited from disclosing the U.S. tax treatment or U.S. tax structure of such Transaction.

We are required to obtain, verify and record certain information that identifies each entity that enters into a formal business relationship with us. We will ask for your complete name, street address, and taxpayer ID number. We may also request corporate formation documents, or other forms of identification, to verify information provided.

Any prices or levels contained herein are preliminary and indicative only and do not represent bids or offers. These indications are provided solely for your information and consideration, are subject to change at any time without notice and are not intended as a solicitation with respect to the purchase or sale of any instrument. The information contained in this presentation may include results of analyses from a quantitative model which represent potential future events that may or may not be realized, and is not a complete analysis of every material fact representing any product. Any estimates included herein constitute our judgment as of the date hereof and are subject to change without any notice. We and/or our affiliates may make a market in these instruments for our customers and for our own account. Accordingly, we may have a position in any such instrument at any time.

Although this material may contain publicly available information about Citi corporate bond research, fixed income strategy or economic and market analysis, Citi policy (i) prohibits employees from offering, directly or indirectly, a favorable or negative research opinion or offering to change an opinion as consideration or inducement for the receipt of business or for compensation; and (ii) prohibits analysts from being compensated for specific recommendations or views contained in research reports. So as to reduce the potential for conflicts of interest, as well as to reduce any appearance of conflicts of interest, Citi has enacted policies and procedures designed to limit communications between its investment banking and research personnel to specifically prescribed circumstances.

© 2022 Citigroup Global Markets Inc. Member SIPC. All rights reserved. Citi and Citi and Arc Design are trademarks and service marks of Citigroup Inc. or its affiliates and are used and registered throughout the world.

© 2022 Citigroup Global Markets Inc. All rights reserved. Citi and Citi and Arc Design are trademarks and service marks of Citigroup Inc. or its affiliates and are used and registered throughout the world.

Citi believes that sustainability is good business practice. We work closely with our clients, peer financial institutions, NGOs and other partners to finance solutions to climate change, develop industry standards, reduce our own environmental footprint, and engage with stakeholders to advance shared learning and solutions. Citi's Sustainable Progress strategy focuses on sustainability performance across three pillars: Environmental Finance; Environmental and Social Risk Management; and Operations and Supply Chain. Our cornerstone initiative is our \$100 Billion Environmental Finance Goal – to lend, invest and facilitate \$100 billion over 10 years to activities focused on environmental and climate solutions.





LACERS Semi-Finalist Presentation Transition Management

November 3, 2022

PRESENTED BY:

Brendan McMahon
Relationship Management

Amanda Williams
NA Head – Transition Management



Amanda Williams, SVP
Regional Practice Lead
North America Region
(312) 557-9461
ATW1@ntrs.com



Brendan McMahon, SVP
Business Dev. &
Relationship Mgmt.
(312) 444-2392
BTM2@ntrs.com



Laura Rogers, VP
Portfolio Manager
North America Region
(312) 557-1423
LM21@ntrs.com



Chris Honold, VP
Strategist
North America Region
(312) 630-8141
CH45@ntrs.com

Amanda has over 20 years of experience working within financial services. Prior to joining Northern Trust in 2020, Amanda held various positions with Merrill Lynch, Charles Schwab, ING, Cetera Financial Group and Raymond James. Her career has been varied and has included holding various roles within operations, serving as a relationship manager, designing and launching a new transition services group for onboarding financial advisors and leading a broker-dealer mergers and acquisitions project team. Amanda's focus with Northern Trust Transition Management is providing regional compliance expertise, improving efficiency for the team and investing in technology and infrastructure improvements. While not focused on work, Amanda enjoys skiing, hot yoga, knitting and spending time with her husband and three children. Amanda earned her BS in Economics from Fayetteville State University (a constituent institution of the University of North Carolina) and later earned an MBA (concentration in Change Management) and an MS in Organizational Management from the University of Colorado. Amanda holds the FINRA Series 7, 63, 9, 10, 24, 65 and 3 registrations and is an Associated Person of the National Futures Association.

Brendan has over 20 years of experience in financial services. Prior to joining Northern Trust, Brendan was an attorney specializing in supporting financial service provider clients in broker-related enforcement and ERISA fiduciary matters. In 2007, Brendan joined Northern Trust as legal counsel supporting Northern Trust Institutional Sales team in securities, fiduciary and global custody banking legal matters. In 2015, he made the leap to serving as a Senior Institutional Sales representative and provided broad-based asset servicing solutions to clients ranging from public fund and corporate retirement plans, foundations and endowments, healthcare systems and Taft-Hartley plans. In 2020, Brendan accepted the role within Transition Management and focuses on consultant relationships. Brendan brings to Transition Management his previous legal expertise and is helpful in navigating challenges and identifying solutions in our complex regulatory environment. Brendan is an avid sports fan, enjoys live music and good food, and loves spending time with his wife, three children and dog. Brendan earned his BA from Miami University (OH) and his JD from Chicago-Kent College of Law. Brendan holds the FINRA Series 7, 63, 65 and 3 registrations and is an Associated Person with the National Futures Association.

Laura began her financial services career over 25 years ago, beginning with True North Communications as a member of the Corporate Treasury department. Laura joined Northern Trust in 1996 and has worked within Operations as an Information Delivery Analyst, within Northern Trust Asset Management (NTAM) as a portfolio manager for passive investment and socially responsible investing, as well as the tax advantage investment management and futures cash overlay team. Laura joined Transition Management in 2007 and has developed expertise in portfolio management, trading, foreign currency (FX) trading, futures trading, risk management and reconciliation. In her free time, Laura enjoys reading, traveling, volunteering and spending time with her husband and two children. Laura obtained her AB from University of Michigan, as well as an MBA (concentration in Finance) from DePaul University. Laura currently holds the FINRA Series 7, 63 and 3 registrations and is an Associated Person of the National Futures Association.

Chris has spent his entire career at Northern Trust, assuming his first role with the company in 2000. Initially, Chris was a Portfolio Accounting Analyst and was quickly promoted to Team Lead and further promoted to Section Manager. In 2006, Chris expanded his knowledge set and pursued additional roles including serving as the Head of Defined Contribution Implementation in Northern Trust Global Investments and as Team Lead of the Restructure Solutions Team within Northern Trust Global Investments. Chris joined the Transition Management department as a Strategist in 2012. With more than 10 years of experience in his current role, Chris brings significant expertise to the transitions he supports. His areas of expertise include knowledge of capital markets, quantitative analysis skills, operations and risk management. Those that know Chris know he is passionate about golfing and spending time with his wife and two children. Chris earned his BS in Finance from Eastern Illinois University. Chris currently holds the FINRA Series 7, 63 and 3 and is an Associated Person of the National Futures Association.

Platform Overview

A dedicated business providing customised event solutions for a global client base



LIQUIDITY ACCESS

Unique liquidity pool and world-class execution capabilities

- 460 equity and fixed income brokers¹
- 82 global markets¹
- 24/6 market coverage¹
- Unique pool of liquidity and scale enables reduced costs for clients



STRATEGY DEVELOPMENT

Removing ambiguity and minimising risk

- Planning phase with robust checklists for all stakeholders
- In-depth project plan.
- Innovative exposure solutions service helps clients bridge the gap between legacy manager and target managers



TRANSPARENCY & REPORTING

Integrity, trust and sophisticated technology

- Full transparency around costs
- Tailored strategies are provided by a suite of pre-trade, intra-trade and post-trade reporting
- All trading activity is independently validated through peer universe data and third-party Transaction Cost Analysis (TCA) providers

UNDERPINNED BY AN EXPERIENCED TEAM

1,000+
TRANSITIONS²

\$400B+
ASSETS
TRANSITIONED²

20
DEDICATED
SPECIALISTS

18
PUBLIC FUND CLIENTS
>15BN ²

30+
YEARS OF TRANSITION
MANAGEMENT

¹As of May 2021; ²For the period 2016-2020; ³Across full Transition Management team

Benefits of Our Unique Model



Faster trading

With our robust network of brokers and crossing counterparties, illiquid and concentrated positions can be traded in substantially less time



Better pricing

Crosses are executed at the midpoint in most cases, providing a better price to both sides of the trade and removing spread and impact costs



Long only counterparties

Our network of crossing counterparties are long-only, well vetted, asset managers and institutional investors



Aligned with you

Our agent only trading model ensures transparency to commissions and costs



Global sales trading

Industry veterans that advocate on your behalf to seek block trading opportunities



Global TM and trading desks

Co-located transition and trading desks provide local expertise, real-time coordination and expert operational knowledge

Looking Ahead

Internal focus on service



Global collaboration and expertise



Expanding Exposure Solutions globally



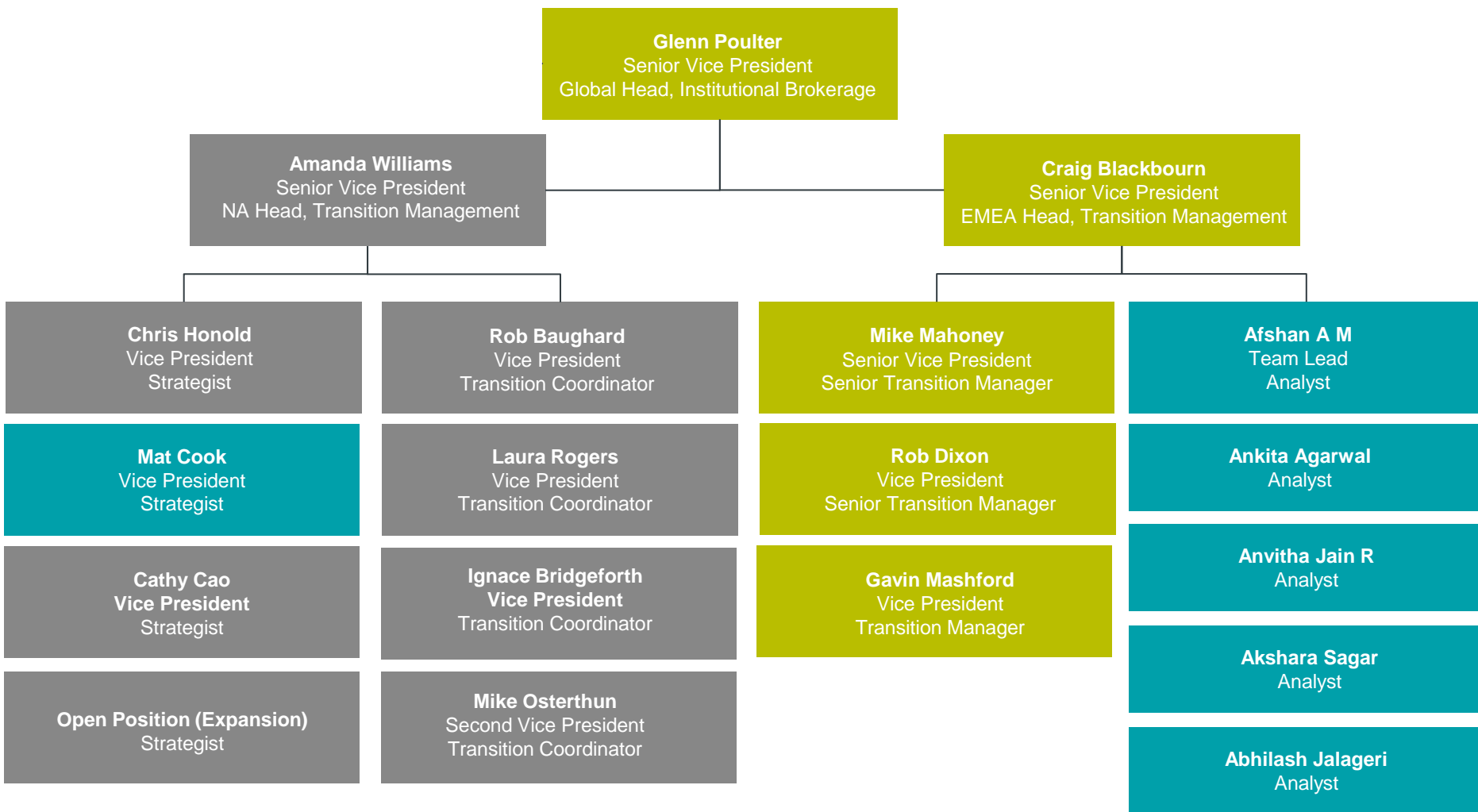
Growing business in APAC



Continued investment in technology



Transition Management Team



Transition Management Team

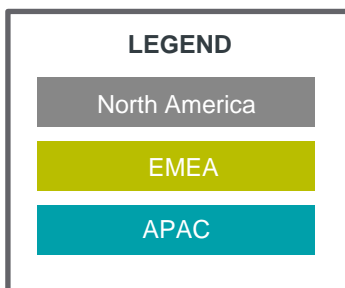
Grant Johnsey
Senior Vice President
Head of Institutional Brokerage

Brendan McMahon
Senior Vice President
Consultant Relations
Transition Management

Bill Kincaid
Senior Vice President
Sales Representative, Americas
Transition Management

Mike Terzich
Senior Vice President
Sales Representative, Americas
Transition Management

David McPhillips
Senior Vice President
Sales Representative, EMEA/APAC
Transition Management



Diversity, Equity & Inclusion Strategy

Our goal is to support Northern Trust's global strategy while ensuring locally relevant DE&I challenges and opportunities are addressed.

ACCOUNTABILITY



Track progress of and hold managers accountable for measurable outcomes

DEVELOPMENT



Create targeted and scalable programs and provide tools focused on early, mid-career and senior level advancement

CULTURE



Enhance Northern Trust culture to create a more diverse, equitable and inclusive environment

MARKETPLACE



Positioning the organisation an employer of choice for diverse talent and working collaboratively to create positive change across-industry

Opportunities for collaboration:



Best practice sharing forums, cross-company discussions and impactful trainings to learn and educate ourselves.



Educational and insightful events to raise awareness, stimulate dialogue and create positive change.



Employability workshops to support diverse communities seeking employment and cross-organisation volunteering opportunities to further inclusion.

DISCLOSURES

IMPORTANT INFORMATION: For Use with Institutional Investors/Financial Professionals Only. Not For Retail Use.

Securities products and services are sold by Registered Representatives of Northern Trust Securities, Inc. (member FINRA, SIPC), a wholly owned subsidiary of Northern Trust Corporation.

The information contained herein is intended for use with current or prospective clients of Northern Trust Investments, Inc. The information is not intended for distribution or use by any person in any jurisdiction where such distribution would be contrary to local law or regulation. Northern Trust and its affiliates may have positions in and may effect transactions in the markets, contracts and related investments different than described in this information. This information is obtained from sources believed to be reliable, and its accuracy and completeness are not guaranteed. Information does not constitute a recommendation of any investment strategy, is not intended as investment advice and does not take into account all the circumstances of each investor. Opinions and forecasts discussed are those of the author, do not necessarily reflect the views of Northern Trust and are subject to change without notice.

This report is provided for informational purposes only and is not intended to be, and should not be construed as, an offer, solicitation or recommendation with respect to any transaction and should not be treated as legal advice, investment advice or tax advice.

Recipients should not rely upon this information as a substitute for obtaining specific legal or tax advice from their own professional legal or tax advisors. References to specific securities and their issuers are for illustrative purposes only and are not intended and should not be interpreted as recommendations to purchase or sell such securities. Indices and trademarks are the property of their respective owners. Information is subject to change based on market or other conditions.

All securities investing and trading activities risk the loss of capital. Each portfolio is subject to substantial risks including market risks, strategy risks, adviser risk and risks with respect to its investment in other structures. There can be no assurance that any portfolio investment objectives will be achieved, or that any investment will achieve profits or avoid incurring substantial losses. No investment strategy or risk management technique can guarantee returns or eliminate risk in any market environment. Risk controls and models do not promise any level of performance or guarantee against loss of principal. Any discussion of risk management is intended to describe Northern Trust's efforts to monitor and manage risk but does not imply low risk.

Northern Trust Asset Management is composed of Northern Trust Investments, Inc., Northern Trust Global Investments Limited, Northern Trust Fund Managers (Ireland) Limited, Northern Trust Global Investments Japan, K.K., NT Global Advisors, Inc., 50 South Capital Advisors, LLC, Belvedere Advisors LLC and investment personnel of The Northern Trust Company of Hong Kong Limited and The Northern Trust Company.

© 2021 Northern Trust Corporation. Head Office: 50 South La Salle Street, Chicago, Illinois 60603 U.S.A.



**NORTHERN
TRUST**



LACERS

TRANSITION MANAGEMENT SEMI-FINALS

November 3, 2022

EMBRACE
THE POSS/BLE®

TEAM OVERVIEW & FIRM DETAILS

TRAVIS BAGLEY, CFA
Director, Transition Management

DOUG MILLER
Senior Director - Relationship Management

Biography



B.S., Finance and Economics,
Central Washington University

Licensed Registered
Representative, FINRA Series
7, 6 & 66 (Russell Investments
Implementation Services, LLC.,
member FINRA)

CFA Charterholder, CFA
Institute

Travis Bagley, CFA

**Director, Transition Management
Russell Investments Implementation Services, LLC**

Travis Bagley leads the communication and strategic positioning of Russell Investments' transition management offering in the Americas. Travis focuses on helping asset managers and plan sponsors develop customized solutions for the transition management market. Prior to his current role, Travis served as the director for Russell Investments' fixed income transition management service and lead the team to become one of the innovators and market leaders in the fixed income transition management market. Travis's current duties included transition strategy development, planning and implementation, operational process oversight, process development, and implementation transaction cost analysis.

Prior to joining Russell Investments in 2000, Travis worked as an investment technology consultant with Cambridge Technology Partners, performing technology consulting for clients such as Franklin Templeton, Robertson Stephens, Fleet Securities and Deutsche Bank Securities, among others. While at Cambridge, Travis worked as a functional lead in developing a broad array of portfolio management and trading applications.

Prior to Cambridge, he worked as assistant vice president of investments for Bennington Capital Management from 1994 to 1998, where he held an array of roles ranging from investment management, to operations, systems and compliance, to marketing and client service. Chief among his responsibilities were performing management, trading and analysis for multiple fixed-income portfolios within a mutual fund complex; managing the day-to-day operations of Bennington's Accessor Funds; developing evaluation systems for operations, investments and compliance; developing marketing materials for Bennington's family of mutual funds; and providing technical support for the firm's proprietary asset allocation model.

Travis is a director of transition management for Russell Investments Implementation Services, LLC, Russell Investments' global trading firm. Russell Investments Implementation Services, LLC is a SEC registered investment adviser and registered broker-dealer, member FINRA/SIPC.

Travis is a member of the Seattle Society of Financial Analysts.

Biography



B.A., University of Washington

Licensed Registered Representative, FINRA Series 7 and 63 (Russell Investments Implementation Services, LLC, member FINRA)

Douglas Miller

Senior Director, Relationship Management Americas Institutional

Doug Miller is director of relationship management for Russell Investments' Americas Institutional business. He represents Russell Investments best thinking across consulting, implementation services and our global investment division. His understanding of the global capital markets and objective oriented investment solutions helps Russell Investments build strategic partnerships with clients, delivering unique investment solutions. He is responsible for managing relationships with the largest corporate and public retirement plans and other large pools of capital in the Western United States.

In Doug's previous role with Russell Investments, he was responsible for establishing new investment management relationships throughout the Mid-West/South-West United States. Working as a strategic partner with client and retirement advisory committees and chief financial officers, Doug helped them understand the scope of the firm's investment solutions and comprehensive OCIO relationships.

Doug also worked within Russell Investments' Index division, where he worked with Russell Investments' investment management clients in the Northeast to establish licensing relationships when Russell Investments owned the index business.

Doug has worked with Parametric Portfolio Associates and Silver Creek Capital in business development roles.

Before joining Russell Investments, Doug was a regional director of U.S. sales for Bank of New York Mellon Corporation. He worked as a strategic partner to plan sponsors, leveraging peer group universe data, and risk and analytics tools to monitor investment managers and overall fund performance.

Prior to entering the investment management industry, Doug held sales, sales management and senior management roles with various firms in the technology industry.

Russell Investments – core competencies



Advice

- > 50 years of consulting experience
- > Advise on \$2.94 trillion in institutional assets*
- > Independent 3rd party manager research



Asset Management

- > 50 years designing customized investment strategies
- > 40 years of building multi-asset solutions
- > \$340.8 billion assets under management



Implementation

- > Over 30 years managing risks and overall portfolio exposures
- > \$229 billion in passive/model-based assets managed internally
- > \$130 billion transitioned in 2021

As of December 31, 2021, unless otherwise noted.

*As of June 30, 2021.

Russell Investments Implementation Services, LLC

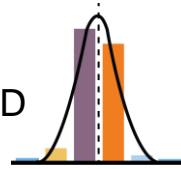
Significant scale and resources, available as an extension of your team



24
HOUR
Trading
capability



\$2.5
TRILLION USD
Traded in
2021



\$130
BILLION USD
Assets
transitioned in
2021 across 190
events



\$743
BILLION USD
Foreign
Exchange
Traded in 2021



90+
Investment
professionals
located globally



\$113
BILLION USD
Managed in
overlay services
globally



35
YEARS
Experience in
implementation
services



Ability to
Trade in over
100+
MARKETS



Source: Russell Investments. As of December 31, 2021 unless otherwise noted.

¹As of March 2022.

Past performance is no guarantee of future results.

Experienced, well resourced global team

More than 35 years transition experience



TEAM



EXPERIENCE



EXPERTISE

20 Global transition team members¹

190 Events in 2021

17 Average years PM experience

Proven Track Record

Over 75% of actual results are within standard deviation of estimates²

20+ Traders specialized by asset class and instrument

\$130.2B USD in Portfolios Transitioned in 2021

Beginning portfolio values



Source: Russell Investments Transition Management Performance Composites, 5-year composite ending 2021 covering 791 transitions. Past performance is not a guide to future performance.

Data as of December 31, 2021, unless otherwise specified.

¹As of October 01, 2022

²As of March 2022

Russell Investments – Firm Information



Vision

- > Primary focus – delivering advisory, asset management and implementation services to the institutional marketplace
- > This is our core business and comprises about 90% of firm revenues



Organizational Structure

- > The firm has structured itself to provide tailored portfolio solutions to larger institutional clients who often desire custom solutions. Russell Investments will continually evolve with our clients to best deliver on this objective.



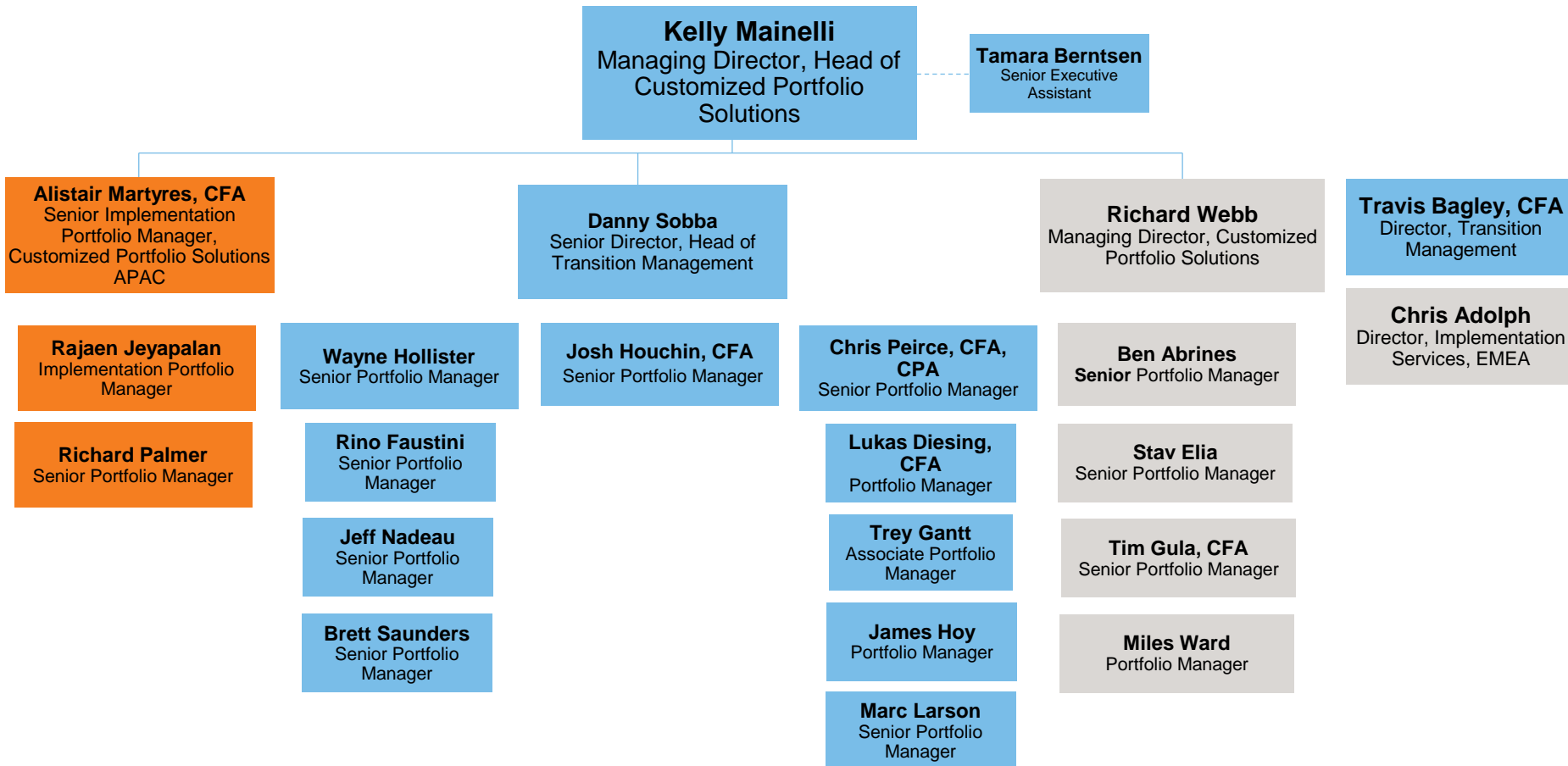
Talent Retention

- > Russell Investments strives to offer competitive compensation (salaries and bonus). Incentive bonuses are related to the overall performance of the firm and specific job performance of the individual. Our associate retention rates are consistently above industry averages.

As of December 31, 2021, unless otherwise noted.

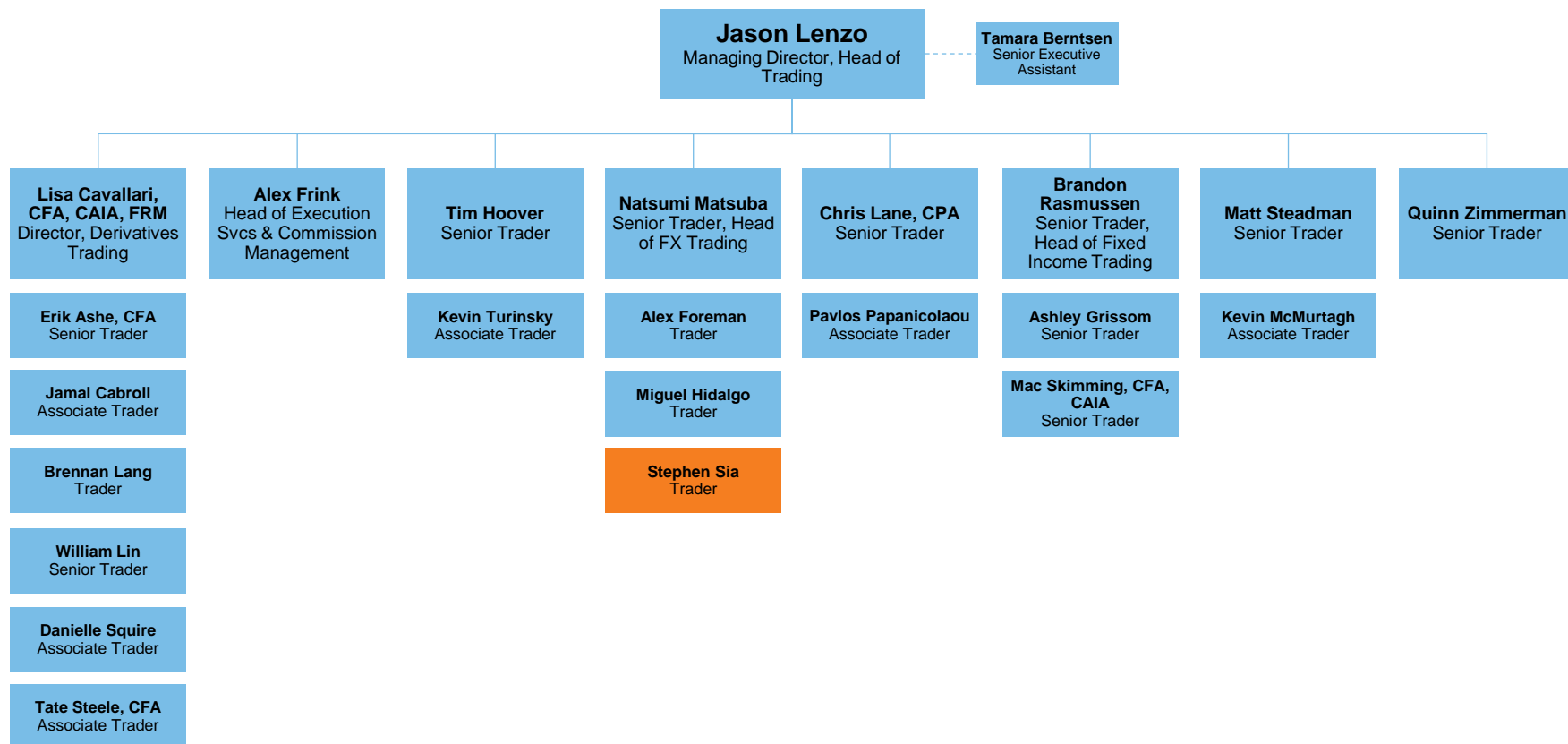
ORGANIZATIONAL CHARTS

Transition Management



As of September 30, 2022

Trading

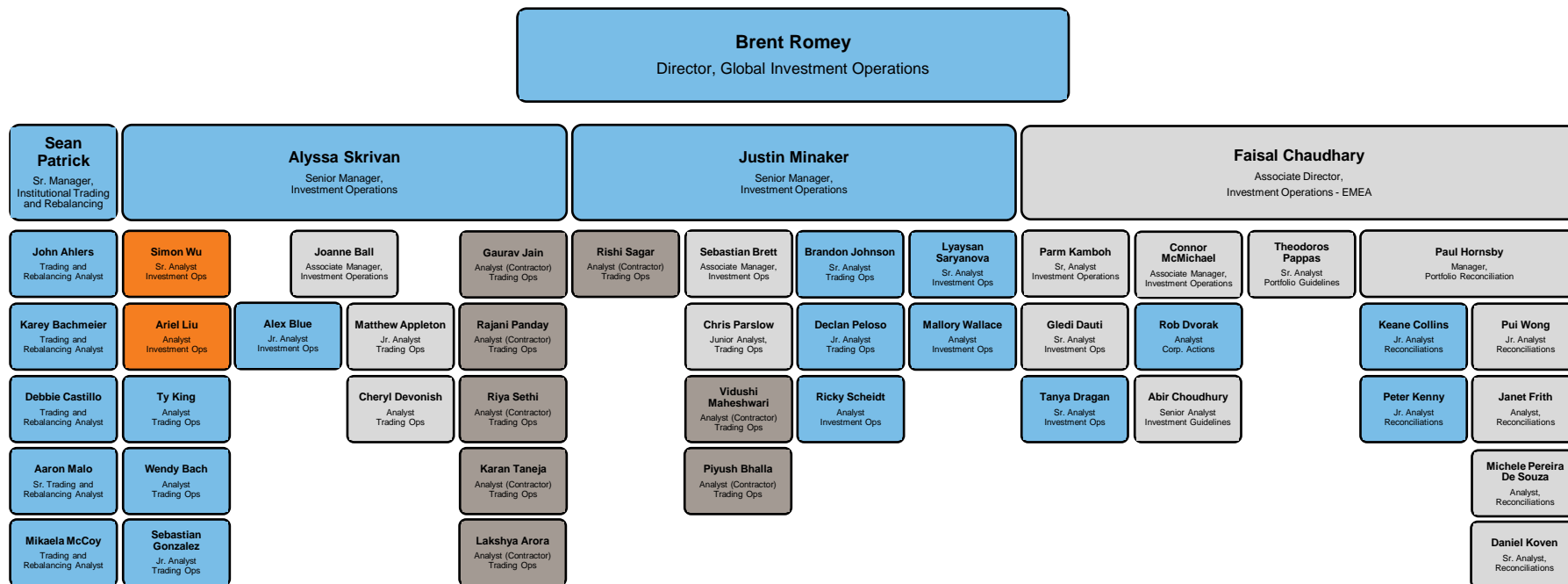


As of September 30, 2022

Americas EMEA Australia

Global Investment Operations

Organizational Structure



As of August 1, 2022

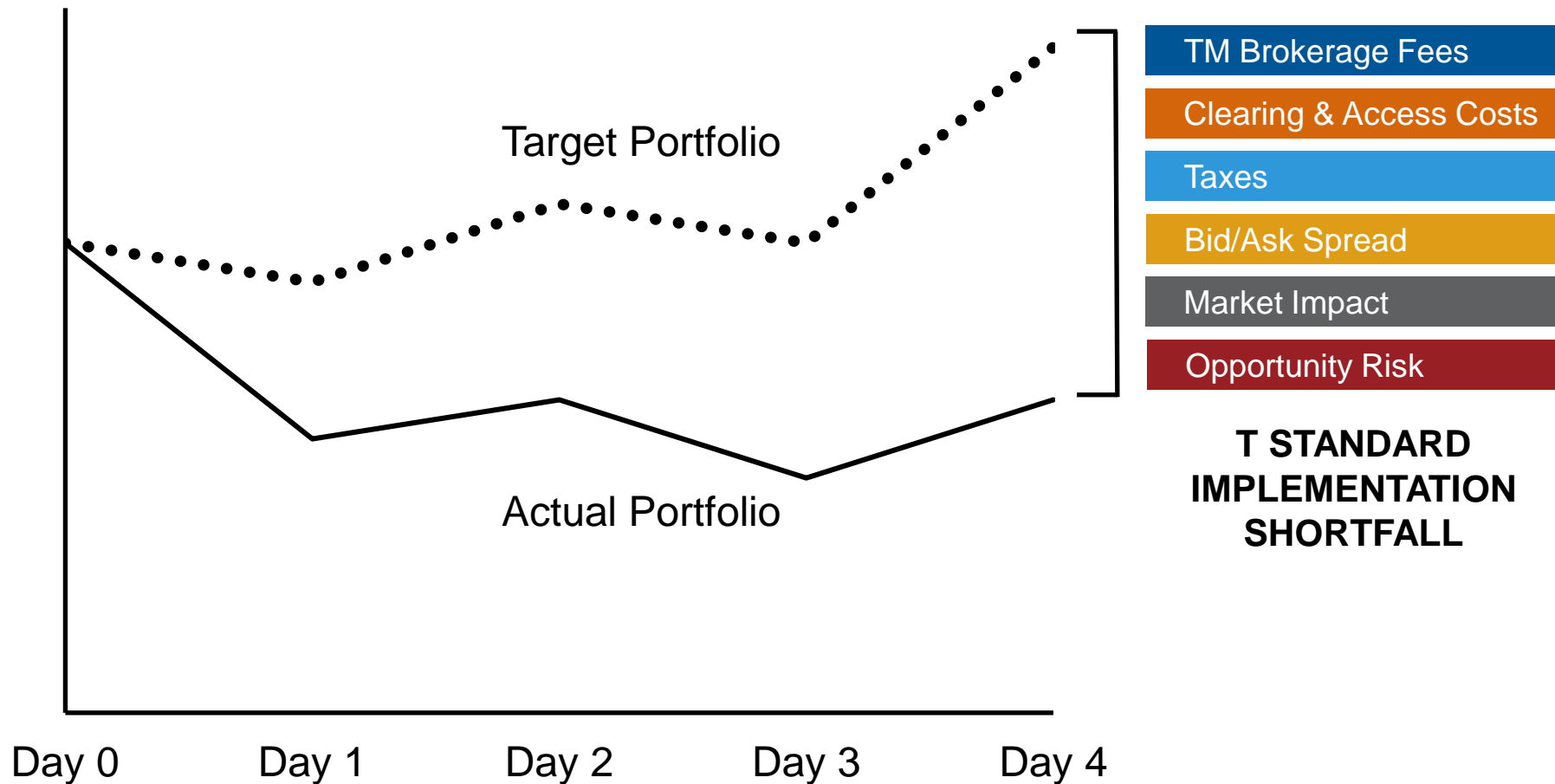
Americas EMEA Australia INDIA

★ Open position

THE TRANSITION PROCESS

Goal: Minimize T Standard Implementation Shortfall

Minimizing all costs: brokerage, taxes, fees, bid/ask spread, market impact and opportunity risk, back to the reference data (Day 0)



Source: Russell Investments. For illustrative purposes.

Focus on the most impactful performance factors

ASSET ALLOCATION

1

Differences in asset classes, for example equity and fixed, are the largest drivers of risk in transition events and should be addressed first in a transition event

PORTFOLIO STRUCTURE

2

Differences in portfolio structure, for example market cap, region, sector, fundamental risk factors; are the second largest driver of risk in transition events

TRADING EFFICIENCY

3

Trading is an important component of transition performance and should be diligently addressed as a pure agent to maximize performance

Major steps in a transition



PRE TRANSITION

LACERS and RIIS complete evergreen agreement

LACERS makes investment manager decision and discusses plan with RIIS

LACERS and RIIS complete addendum to evergreen agreement

RIIS reviews portfolio holdings and provides pre-transition estimate using the T-Standard

RIIS consults with LACERS, custodian and managers on issues including holidays, markets, currencies, illiquid holdings, etc.

LACERS, RIIS and custodian have “Kick Off Call” to review plan



TRANSITION

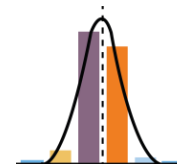
RIIS begins transitioning assets, focusing on hierarchy of risks (asset allocation, portfolio structure, trading)

RIIS provides operational oversight, pricing support and settlement management

RIIS provides daily performance using T-Standard

RIIS frequently communicates with LACERS and custodian

RIIS frequently consults with managers on specific names and events



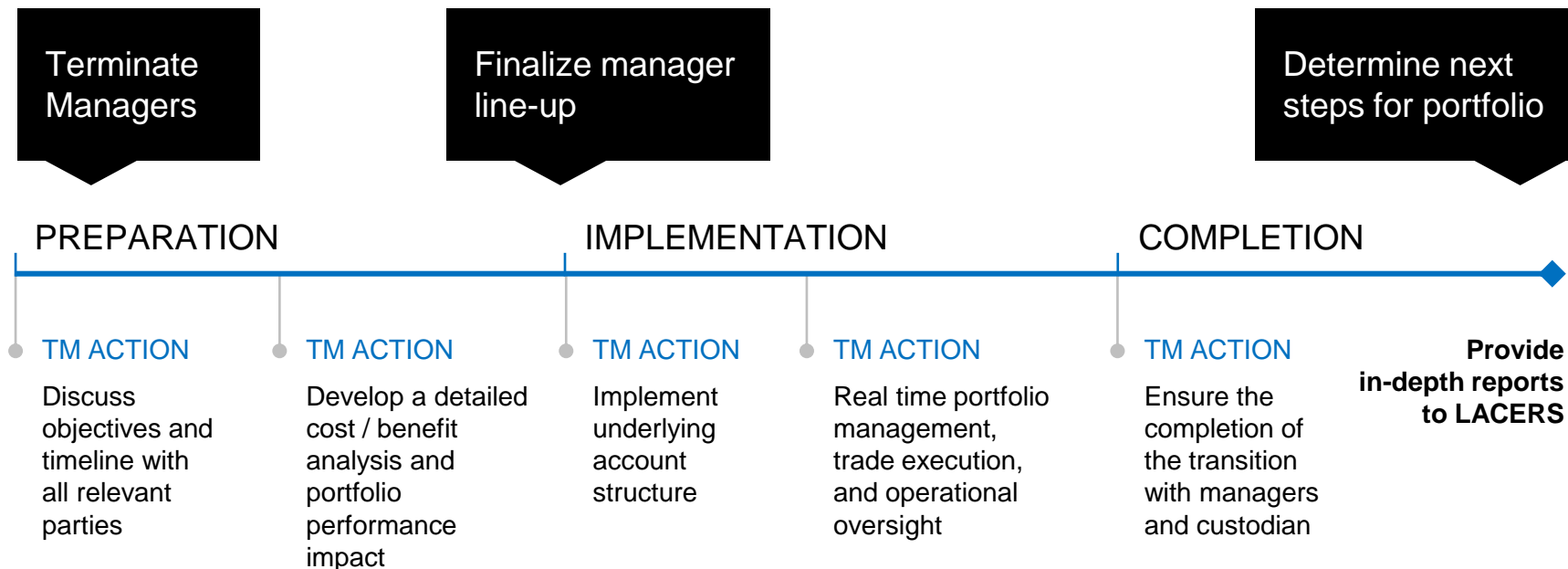
POST TRANSITION

RIIS provides post-transition analysis including performance versus estimate using T-Standard

LACERS and RIIS hold post-transition review meeting

RIIS provides help on any outstanding settlement issues

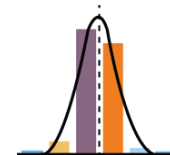
Adding value throughout the transition



Our integrated transition management and trading teams are intimately involved in the transition process. Trading over \$2.5 trillion in 2021, RIIS has the insight, experience and scale to minimize performance slippage and costs.

Source: Russell Investments TM = Transition Manager

Why Partner with RIIS?



BUSINESS MODEL

- Fiduciary - 1940 Act Adviser*
- Full transparency to fees
- Agency only, no rebates or PFOF
- Unbiased venue selection

HISTORY AND EXPERIENCE

- 19 dedicated TM PMs
- 90+ implementation professionals
- 35+ years experience in TM
- Experts in large complex events

PERFORMANCE TRACK RECORD

- T Standard measurement
- 73% of events within 1 Std. Dev.
- 1,638 events in past 10 yrs.
- Delivering on expectations

Over the last 10 years our performance estimates have been within **5 bps** of actual results¹

Source: Russell Investments. Data as of December 2021.

¹Transition Management Performance Composites, 10 year composite ending 2021. Past performance is not a guarantee of future performance. For illustrative purposes only.

*Dually registered as an Investment Adviser and Broker Dealer



THANK YOU!

ANY QUESTIONS?

Important information

Pensions & Investments Top Tier Broker 2022

In 37 out of 42 most recent quarters, Russell Investments Implementation Services, LLC has been ranked as a top-tier broker in *Pensions & Investments'* Tradewatch report based on the quality of its trade execution (most recently in *P&I's* March 2022 issue).

Rankings are based on best-performing brokers as measured by the difference in cost/savings against the universe of Elkins/McSherry, a State Street company. The Elkins/McSherry universe is based on the top 50 brokers in each category by U.S. dollar volume. This is a quarterly ranking based on the previous four-quarters as of December 31, 2021.

European Pensions Awards Currency Manager of Year 2019

Russell Investments was named the winner of the "Currency Manager of the Year" at the 2019 European Pensions Awards. Chosen among 12 finalists in this category, Pensions Age and European Pensions cited Russell Investments' "excellent commitment to improving outcomes for both its clients and the wider industry, with its unrivalled ability to manage currency risk, as well as reducing execution cost

Important information and disclosures

Nothing contained in this material is intended to constitute legal, tax, securities, or investment advice, nor an opinion regarding the appropriateness of any investment, nor a solicitation of any type. The general information contained in this publication should not be acted upon without obtaining specific legal, tax, and investment advice from a licensed professional.

Copyright© 2022 Russell Investments. All rights reserved. This material is proprietary and may not be reproduced, transferred, or distributed in any form without prior written permission from Russell Investment. It is delivered on an “as is” basis without warranty.

Securities products and services offered through Russell Investments Implementation Services, LLC, part of Russell Investments, a SEC Registered investment adviser and broker-dealer, member FINRA, SIPC. Russell Investments Implementation Services, LLC is a wholly owned subsidiary of Russell Investments US Institutional HoldCo.

Diversification and strategic asset allocation do not assure profit or protect against loss in declining markets. Russell Investments' ownership is composed of a majority stake held by funds managed by TA Associates, with a significant minority stake held by funds managed by Reverence Capital Partners. Russell Investments' employees and Hamilton Lane Advisors, LLC also hold minority, non-controlling, ownership stakes.

Frank Russell Company is the owner of the Russell trademarks contained in this material and all trademark rights related to the Russell trademarks, which the members of the Russell Investments group of companies are permitted to use under license from Frank Russell Company. The members of the Russell Investments group of companies are not affiliated in any manner with Frank Russell Company or any entity operating under the “FTSE RUSSELL” brand.

The Russell Investments' logo is a trademark and service mark of Russell Investments.

Standard & Poor's Corporation is the owner of the trademarks, service marks, and copyrights related to its indexes.

Indexes and/or benchmarks are unmanaged and cannot be invested in directly. Returns represent past performance, are not a guarantee of future performance, and are not indicative of any specific investment.

MSCI makes no express or implied warranties or representations and shall have no liability whatsoever with respect to any MSCI data contained herein. The MSCI data may not be further redistributed or used to create indices or financial products. This report is not approved or produced by MSCI.

Unless otherwise noted, source for the data in this presentation is Russell Investments Implementation Services, LLC.

This material is a product of Russell Investments Implementation Services, LLC, a registered investment advisor and broker-dealer, member FINRA, SIPC.

Date of first use: November 2022
RIIS-04266

CONTRACT FOR
ABEL NOSER, LLC
INVESTMENT TRANSITION MANAGEMENT SERVICES

PROPOSED RESOLUTION

WHEREAS, on January 25, 2022, the Board authorized an Investment Transition Management Services Request for Proposal (RFP) to refresh LACERS' bench of transition managers; and,

WHEREAS, on July 12, 2022, the Investment Committee considered staff's evaluation report of the RFP respondents, including the five proposed semi-finalist candidates: Abel Noser, LLC; BlackRock Institutional Trust Company, N.A.; Citigroup Global Markets Inc.; The Northern Trust Company; and Russell Investments Implementation Services, LLC; and,

WHEREAS, staff subsequently conducted further due diligence on the semi-finalist candidates and deemed all five firms capable of providing investment transition management services to LACERS; and,

WHEREAS, on November 3, 2022, the Investment Committee interviewed the five semi-finalist candidates and advanced all five firms as finalist candidates for consideration by the Board for five-year contract awards; and,

WHEREAS, on November 22, 2022, the Board approved the Investment Committee's recommendation to hire Abel Noser, LLC; BlackRock Institutional Trust Company, N.A.; Citigroup Global Markets Inc.; The Northern Trust Company; and Russell Investments Implementation Services, LLC to comprise LACERS' bench of transition managers.

NOW, THEREFORE, BE IT RESOLVED, that the General Manager is hereby authorized to approve and execute a contract, subject to satisfactory business and legal terms and consistent with the following services and terms:

<u>Company Name:</u>	Abel Noser, LLC
<u>Service Provided:</u>	Investment Transition Management
<u>Approximate Effective Dates:</u>	February 1, 2023 through January 31, 2028
<u>Duration:</u>	Five years

November 22, 2022

CONTRACT FOR
BLACKROCK INSTITUTIONAL TRUST COMPANY, N.A.
INVESTMENT TRANSITION MANAGEMENT SERVICES

PROPOSED RESOLUTION

WHEREAS, on January 25, 2022, the Board authorized an Investment Transition Management Services Request for Proposal (RFP) to refresh LACERS' bench of transition managers; and,

WHEREAS, on July 12, 2022, the Investment Committee considered staff's evaluation report of the RFP respondents, including the five proposed semi-finalist candidates: Abel Noser, LLC; BlackRock Institutional Trust Company, N.A.; Citigroup Global Markets Inc.; The Northern Trust Company; and Russell Investments Implementation Services, LLC; and,

WHEREAS, staff subsequently conducted further due diligence on the semi-finalist candidates and deemed all five firms capable of providing investment transition management services to LACERS; and,

WHEREAS, on November 3, 2022, the Investment Committee interviewed the five semi-finalist candidates and advanced all five firms as finalist candidates for consideration by the Board for five-year contract awards; and,

WHEREAS, on November 22, 2022, the Board approved the Investment Committee's recommendation to hire Abel Noser, LLC; BlackRock Institutional Trust Company, N.A.; Citigroup Global Markets Inc.; The Northern Trust Company; and Russell Investments Implementation Services, LLC to comprise LACERS' bench of transition managers.

NOW, THEREFORE, BE IT RESOLVED, that the General Manager is hereby authorized to approve and execute a contract, subject to satisfactory business and legal terms and consistent with the following services and terms:

<u>Company Name:</u>	BlackRock Institutional Trust Company, N.A.
<u>Service Provided:</u>	Investment Transition Management
<u>Approximate Effective Dates:</u>	February 1, 2023 through January 31, 2028
<u>Duration:</u>	Five years

November 22, 2022

CONTRACT FOR
CITIGROUP GLOBAL MARKETS INC.
INVESTMENT TRANSITION MANAGEMENT SERVICES

PROPOSED RESOLUTION

WHEREAS, on January 25, 2022, the Board authorized an Investment Transition Management Services Request for Proposal (RFP) to refresh LACERS' bench of transition managers; and,

WHEREAS, on July 12, 2022, the Investment Committee considered staff's evaluation report of the RFP respondents, including the five proposed semi-finalist candidates: Abel Noser, LLC; BlackRock Institutional Trust Company, N.A.; Citigroup Global Markets Inc.; The Northern Trust Company; and Russell Investments Implementation Services, LLC; and,

WHEREAS, staff subsequently conducted further due diligence on the semi-finalist candidates and deemed all five firms capable of providing investment transition management services to LACERS; and,

WHEREAS, on November 3, 2022, the Investment Committee interviewed the five semi-finalist candidates and advanced all five firms as finalist candidates for consideration by the Board for five-year contract awards; and,

WHEREAS, on November 22, 2022, the Board approved the Investment Committee's recommendation to hire Abel Noser, LLC; BlackRock Institutional Trust Company, N.A.; Citigroup Global Markets Inc.; The Northern Trust Company; and Russell Investments Implementation Services, LLC to comprise LACERS' bench of transition managers.

NOW, THEREFORE, BE IT RESOLVED, that the General Manager is hereby authorized to approve and execute a contract, subject to satisfactory business and legal terms and consistent with the following services and terms:

<u>Company Name:</u>	Citigroup Global Markets Inc.
<u>Service Provided:</u>	Investment Transition Management
<u>Approximate Effective Dates:</u>	February 1, 2023 through January 31, 2028
<u>Duration:</u>	Five years

November 22, 2022

CONTRACT FOR
THE NORTHERN TRUST COMPANY
INVESTMENT TRANSITION MANAGEMENT SERVICES

PROPOSED RESOLUTION

WHEREAS, on January 25, 2022, the Board authorized an Investment Transition Management Services Request for Proposal (RFP) to refresh LACERS' bench of transition managers; and,

WHEREAS, on July 12, 2022, the Investment Committee considered staff's evaluation report of the RFP respondents, including the five proposed semi-finalist candidates: Abel Noser, LLC; BlackRock Institutional Trust Company, N.A.; Citigroup Global Markets Inc.; The Northern Trust Company; and Russell Investments Implementation Services, LLC; and,

WHEREAS, staff subsequently conducted further due diligence on the semi-finalist candidates and deemed all five firms capable of providing investment transition management services to LACERS; and,

WHEREAS, on November 3, 2022, the Investment Committee interviewed the five semi-finalist candidates and advanced all five firms as finalist candidates for consideration by the Board for five-year contract awards; and,

WHEREAS, on November 22, 2022, the Board approved the Investment Committee's recommendation to hire Abel Noser, LLC; BlackRock Institutional Trust Company, N.A.; Citigroup Global Markets Inc.; The Northern Trust Company; and Russell Investments Implementation Services, LLC to comprise LACERS' bench of transition managers.

NOW, THEREFORE, BE IT RESOLVED, that the General Manager is hereby authorized to approve and execute a contract, subject to satisfactory business and legal terms and consistent with the following services and terms:

<u>Company Name:</u>	The Northern Trust Company
<u>Service Provided:</u>	Investment Transition Management
<u>Approximate Effective Dates:</u>	February 1, 2023 through January 31, 2028
<u>Duration:</u>	Five years

November 22, 2022

CONTRACT FOR
RUSSELL INVESTMENTS IMPLEMENTATION SERVICES, LLC
INVESTMENT TRANSITION MANAGEMENT SERVICES

PROPOSED RESOLUTION

WHEREAS, on January 25, 2022, the Board authorized an Investment Transition Management Services Request for Proposal (RFP) to refresh LACERS' bench of transition managers; and,

WHEREAS, on July 12, 2022, the Investment Committee considered staff's evaluation report of the RFP respondents, including the five proposed semi-finalist candidates: Abel Noser, LLC; BlackRock Institutional Trust Company, N.A.; Citigroup Global Markets Inc.; The Northern Trust Company; and Russell Investments Implementation Services, LLC; and,

WHEREAS, staff subsequently conducted further due diligence on the semi-finalist candidates and deemed all five firms capable of providing investment transition management services to LACERS; and,

WHEREAS, on November 3, 2022, the Investment Committee interviewed the five semi-finalist candidates and advanced all five firms as finalist candidates for consideration by the Board for five-year contract awards; and,

WHEREAS, on November 22, 2022, the Board approved the Investment Committee's recommendation to hire Abel Noser, LLC; BlackRock Institutional Trust Company, N.A.; Citigroup Global Markets Inc.; The Northern Trust Company; and Russell Investments Implementation Services, LLC to comprise LACERS' bench of transition managers.

NOW, THEREFORE, BE IT RESOLVED, that the General Manager is hereby authorized to approve and execute a contract, subject to satisfactory business and legal terms and consistent with the following services and terms:

<u>Company Name:</u>	Russell Investments Implementation Services, LLC
<u>Service Provided:</u>	Investment Transition Management
<u>Approximate Effective Dates:</u>	February 1, 2023 through January 31, 2028
<u>Duration:</u>	Five years

November 22, 2022



REPORT TO BOARD OF ADMINISTRATION

From: Investment Committee
Elizabeth Lee, Chair
Nilza R. Serrano
Janna Sidley

MEETING: NOVEMBER 22, 2022
ITEM: VIII - C

SUBJECT: INVESTMENT MANAGER CONTRACT WITH AXIOM INVESTORS, LLC REGARDING THE MANAGEMENT OF AN ACTIVE NON-U.S. EMERGING MARKETS GROWTH EQUITIES PORTFOLIO AND POSSIBLE BOARD ACTION

ACTION: CLOSED: CONSENT: RECEIVE & FILE:

Recommendation

That the Board:

1. Approve a one-year contract extension with Axiom Investors, LLC for management of an active non-U.S. emerging markets growth equities portfolio.
2. Authorize the General Manager to approve and execute the necessary documents, subject to satisfactory business and legal terms.

Executive Summary

On November 8, 2022, the Committee considered a staff recommendation to extend the contract with Axiom Investors, LLC for a period of one year. Upon discussing the firm, performance of the strategy, and alternatives to extending the contract, the Committee concurred with the staff recommendation.

Discussion

On November 8, 2022, the Committee considered the attached staff report (Attachment 1) recommending a one-year contract extension with Axiom Investors, LLC (Axiom). The Board hired Axiom through the 2013 Active Emerging Market Growth Equities manager search and authorized a three-year contract on July 23, 2013. The contract became effective on January 1, 2014; the current contract extension expires on December 31, 2022. Since inception, LACERS has paid Axiom a total of \$19.1 million in investment management fees as of June 30, 2022. As of September 30, 2022, LACERS' portfolio was valued at \$256 million. From April 17, 2019, to September 30, 2022, Axiom was on "On Watch" status for organizational changes and a strategy benchmark change. The firm was recently

removed from the watch list upon determination by staff and LACERS' General Consultant, NEPC, LLC (NEPC), that Axiom had appropriately addressed all issues.

Staff explained Axiom's current underperformance relative the MSCI Emerging Markets Index is the result of a market rotation from growth stocks to value stocks. Staff continues to have conviction in Axiom's investment process and ability to add value over the long-term. The Committee inquired about alternative actions if a contract extension was not granted. Staff explained that moving the assets to a passive emerging markets growth strategy would be an option, albeit an unfavorable one. As previously discussed with the Committee and Board, the MSCI Emerging Markets Growth Index is highly concentrated in three Asia technology stocks and would not provide a prudent level of portfolio diversification. Additionally, NEPC's research suggests that active management has a higher probability of outperforming passive management in emerging markets. Further, Axiom's longer-term historical performance has consistently ranked in the first and second quartile of its peer universe (excluding the most recent quarter-end). Staff and NEPC will continue to closely monitor Axiom's performance according to the LACERS Manager Monitoring Policy. Based on the discussion and responses by staff, the Committee concurred with the recommendation to extend Axiom's contract for a one-year period.

Strategic Plan Impact Statement

A contract extension with Axiom will allow the fund to maintain a diversified exposure to non-U.S. emerging markets growth equities, which is expected to help optimize long-term risk adjusted investment returns (Goal IV). The discussion of the investment manager's profile, strategy, performance, and management fee structure is consistent with Goal V (uphold good governance practices which affirm transparency, accountability, and fiduciary duty).

Prepared By: Ellen Chen, Investment Officer II, Investment Division

NMG/RJ/BF/EC:rm

Attachments: 1. Investment Committee Recommendation Report dated November 8, 2022
2. Proposed Resolution



LACERS
LA CITY EMPLOYEES'
RETIREMENT SYSTEM



REPORT TO INVESTMENT COMMITTEE
From: Neil M. Guglielmo, General Manager

MEETING: NOVEMBER 8, 2022
ITEM: VI

SUBJECT: INVESTMENT MANAGER CONTRACT WITH AXIOM INVESTORS, LLC REGARDING THE MANAGEMENT OF AN ACTIVE NON-U.S. EMERGING MARKETS GROWTH EQUITIES PORTFOLIO AND POSSIBLE COMMITTEE ACTION

ACTION: CLOSED: CONSENT: RECEIVE & FILE:

Recommendation

That the Committee recommend to the Board a one-year contract extension with Axiom Investors, LLC for management of an active non-U.S. emerging markets growth equities portfolio.

Executive Summary

Axiom Investors, LLC (Axiom) has managed an active non-U.S. emerging markets growth equities portfolio for LACERS since April 2014. LACERS' portfolio is currently valued at \$256 million as of September 30, 2022. Axiom was initially placed on "On Watch" status for performance effective April 17, 2019, but Axiom's performance improved, and the firm no longer triggered "On Watch" status for performance as of June 30, 2020. However, Axiom's watch status was subsequently extended on various dates due to a benchmark change from the MSCI Emerging Markets Growth (MSCI EM Growth) Index to the MSCI Emerging Markets (MSCI EM) Index, the departure of Christopher Lively, Co-lead Portfolio Manager, and the departure of Kurt Polk, President. After monitoring these matters over the last two years, staff and LACERS' General Consultant, NEPC, LLC (NEPC) are satisfied that Axiom has appropriately addressed these issues and have removed Axiom from "On Watch" status. While Axiom's performance as of September 30, 2022, lags behind the benchmark's performance over all time periods, Axiom has not breached the metrics required to be placed on "On Watch" status for performance reasons. Staff and NEPC recommend a one-year contract extension and will continue to monitor the organization and performance of the strategy in accordance with the LACERS Manager Monitoring Policy (Policy).

Discussion

Background

Axiom has managed an active non-U.S. emerging markets growth equities portfolio for LACERS since April 2014 and is benchmarked against the MSCI EM Index. Axiom uses a fundamental research-based investment strategy that focuses on companies exhibiting key growth drivers, such as company-specific improvements and favorable macroeconomic and political factors. Such drivers tend to be indicators of positive company financial and stock price performance. The 13-person investment team is led by four

Co-lead Portfolio Managers: Andrew Jacobson, Chief Executive Officer and Chief Investment Officer (35 years of experience); Donald Elefson, CFA (40 years of experience); Jose Morales, CFA (34 years of experience); and Young Kim (24 years of experience).

The Board hired Axiom through the 2013 Active Emerging Market Growth Equities manager search process and authorized a three-year contract on July 23, 2013; the contract became effective on January 1, 2014. Axiom was awarded a three-year contract renewal on September 27, 2016, and one-year extensions on July 23, 2019; July 28, 2020; and October 26, 2021. The current contract expires on December 31, 2022. Axiom had been on "On Watch" status since April 17, 2019, and was recently removed from the watch list, as discussed in the Due Diligence section of this report.

Organization

Axiom is 100% employee-owned, with 61 employees, and is headquartered in Greenwich, Connecticut. As of September 30, 2022, the firm managed over \$15.4 billion in total assets with \$5.4 billion in the emerging markets growth equities strategy.

Due Diligence

Axiom's investment philosophy, strategy, and process have not changed over the one-year contract extension period. Axiom was initially placed on "On Watch" status for performance on April 17, 2019. After conducting a thorough review of Axiom's underperformance relative to its benchmark in place at the time, the MSCI EM Growth Index, staff and NEPC determined that the MSCI EM Growth Index had become increasingly concentrated in a few stocks since inception of LACERS' account and that the benchmark was no longer an effective measure by which to compare Axiom's strategy. As of June 30, 2020, Axiom no longer triggered watch status due to performance. However, on July 28, 2020, the Board approved a change of Axiom's benchmark from the MSCI EM Growth Index to the more diversified MSCI EM Index with the condition that Axiom remain on watch through August 1, 2021, in order to monitor Axiom for consistency with its stated strategy. The benchmark change became effective on August 1, 2020.

Subsequently, two material organizational changes at Axiom led to further extensions of Axiom's watch status. First, on September 29, 2020, Axiom announced that Chris Lively would be stepping down from his role as co-lead portfolio manager of the emerging markets growth equities strategy for personal reasons, triggering an extension of Axiom's existing watch status to October 1, 2021. Andrew Jacobson, Axiom's founder, CEO and CIO, and the original architect of the strategy, replaced Mr. Lively as co-lead of the strategy alongside Donald Elefson and Jose Morales. In addition, Axiom hired Young Kim in March 2021 as a fourth co-lead portfolio manager to expand the team's capabilities.

Second, on August 18, 2021, Axiom announced that Kurt Polk, Axiom's President, would be leaving the firm at the end of the year for personal reasons, triggering a further extension of Axiom's existing watch status to October 1, 2022. The firm has no plans to fill the President position. Axiom's existing management committee has assumed Mr. Polk's responsibilities and currently consists of the following members: Edward Azimi, Chief Operating Officer; Lindsay Chamberlain, Managing Director of Client Partnerships; Jonathan Ellis, Director of Research and Portfolio Manager; Andrew Jacobson, CEO and CIO; and Denise Zambardi, Senior Vice President and Chief Compliance Officer and Controller. Further, Axiom has hired additional support personnel for the management committee members.

After closely monitoring and conducting routine due diligence on Axiom’s organizational changes and the strategy’s benchmark change over the last two years, staff and NEPC are satisfied that Axiom has appropriately addressed these matters. The changes have not resulted in any changes to Axiom’s stated investment philosophy and strategy, nor have they had a material adverse impact to the management of the investment strategy and LACERS assets. Accordingly, staff and NEPC have removed Axiom from “On Watch” status.

Performance

As discussed in the Due Diligence section, Axiom’s benchmark was changed from the MSCI EM Growth Index to the MSCI EM Index effective August 1, 2020. Since the effective date of the benchmark change, Axiom has underperformed in all periods compared to the MSCI EM Index as presented in the following table. With the rotation of the market from favoring growth stocks to favoring value stocks that began at the end of 2021, the underperformance of Axiom’s growth-oriented strategy relative to the MSCI EM Index, an index comprised of growth and value stocks, is expected. The benchmark change has not resulted in any changes to Axiom’s investment process, and the strategy continues to be managed according to the same investment philosophy and process in place at the time of hire.

Annualized Performance as of 9/30/22 (Net-of-Fees)				
	3-month	1-Year	2-Year	Since 8/1/2020
Axiom	-14.25	-36.24	-13.30	-11.32
MSCI EM Index	-11.57	-28.11	-7.82	-7.00
<i>% of Excess Return</i>	-2.68	-8.13	-5.48	-4.32

The following table presents Axiom’s performance since inception of the account on April 11, 2014, relative to a blended benchmark that incorporates the performance of the previous MSCI EM Growth Index from account inception date to July 31, 2020, and the performance of the MSCI EM Index from August 1, 2020 to September 30, 2022. Axiom’s underperformance over the three-year, five-year, and since inception time periods is due to the high stock concentration of the former MSCI EM Growth benchmark and LACERS’ investment guideline limitations that required Axiom’s portfolio to be more diversified than the former benchmark. Please refer to October 26, 2021, report to the Board (Attachment 1) for a detailed discussion of Axiom’s underperformance relative to the MSCI EM Growth Index. In light of the benchmark change, historical blended benchmark performance (the three-year, five-year, and since inception time periods) provides minimal value in evaluating the effectiveness of Axiom’s strategy. The current benchmark, the MSCI EM Index, as presented in the preceding table, is a more appropriate measure of Axiom’s performance considering portfolio diversification requirements of the investment guidelines.

Annualized Performance as of 9/30/22 (Net-of-Fees)						
	3-month	1-Year	2-Year	3-Year	5-Year	Since Inception
Axiom	-14.25	-36.24	-13.30	-2.66	-2.07	1.17
Axiom Blended Benchmark*	-11.57	-28.11	-7.82	2.14	0.68	3.26
<i>% of Excess Return</i>	<i>-2.68</i>	<i>-8.13</i>	<i>-5.48</i>	<i>-4.80</i>	<i>-2.75</i>	<i>-2.09</i>

*Axiom Blended Benchmark incorporates MSCI EM Growth Index returns prior to August 1, 2020 and MSCI EM Index returns from August 1, 2020 to present.

Calendar year performance is presented in the table below as supplemental information.

Calendar Year Performance as of 12/31/21 (Net-of-Fees)								
	2021	2020	2019	2018	2017	2016	2015	4/11/14-12/31/14
Axiom	-4.28	32.46	24.70	-17.64	40.56	8.40	-12.44	-2.01
Axiom Blended Benchmark	-2.54	32.02	25.10	-18.26	46.80	7.59	-11.34	-2.24
<i>% of Excess Return</i>	<i>-1.74</i>	<i>0.44</i>	<i>-0.40</i>	<i>0.62</i>	<i>-6.24</i>	<i>0.81</i>	<i>-1.10</i>	<i>0.23</i>

Staff recognizes that Axiom’s strategy has underperformed since the date of the benchmark change (August 1, 2020) and since inception (April 11, 2014) compared to the blended benchmark. Evaluating Axiom’s performance against the watch list criteria, Axiom’s performance is currently in compliance with the Policy, which requires both a peer performance metric and information ratio metric to be breached over two consecutive quarters before placing a manager on “On Watch” status for performance. As presented in the following table, Axiom breached the metrics as of September 30, 2022, and was within the established guidelines as of June 30, 2022.

Evaluation of Watch List Status				
Manager	Metric 1		Metric 2	
	Underperforms (net of fees) trailing 5-year peer median performance (i.e., peer rank between 50th and 100th percentile)		Trailing 5-year Information Ratio falls below 0.20	
	Peer Ranking 9/30/2022	Peer Ranking 6/30/2022	Information Ratio 9/30/2022	Information Ratio 6/30/2022
Axiom	64 (fail)	37 (pass)	-0.03 (fail)	0.51 (pass)

Staff and NEPC will continue to closely monitor Axiom's organization and performance according to the Policy and take appropriate action as necessary.

Fees

LACERS pays Axiom an effective fee of 60 basis points (0.60%), which is approximately \$1.5 million annually based on the value of LACERS' assets as of September 30, 2022. This fee ranks in the 22nd percentile among its peers in the eVestment Global Emerging Markets All Cap Growth Equity Universe (i.e., Axiom's fee is lower than 78% of peers). Since inception, LACERS has paid Axiom a total of \$19.1 million in investment manager fees as of June 30, 2022.

General Fund Consultant Opinion

NEPC concurs with these recommendations.

Strategic Plan Impact Statement

A contract extension with Axiom will allow the fund to maintain a diversified exposure to the non-U.S. equities emerging markets, which is expected to help optimize long-term risk adjusted investment returns (Goal IV). The discussion of the investment manager's profile, strategy, performance, and management fee structure are consistent with Goal V (uphold good governance practices which affirm transparency, accountability, and fiduciary duty).

Prepared by: Ellen Chen, Investment Officer II, Investment Division

RJ/BF/EC:rm

Attachments: 1. Report to Board of Administration Dated October 26, 2021
 2. Consultant Recommendation – NEPC, LLC



LACERS
LA CITY EMPLOYEES'
RETIREMENT SYSTEM



REPORT TO BOARD OF ADMINISTRATION

From: Investment Committee
Sung Won Sohn, Chair
Elizabeth Lee
Nilza R. Serrano

MEETING: OCTOBER 26, 2021
ITEM: X-C

SUBJECT: INVESTMENT MANAGER CONTRACT WITH AXIOM INVESTORS, LLC REGARDING THE MANAGEMENT OF AN ACTIVE NON-U.S. EMERGING MARKETS GROWTH EQUITIES PORTFOLIO AND POSSIBLE BOARD ACTION

ACTION: CLOSED: CONSENT: RECEIVE & FILE:

Recommendation

That the Board:

1. Approve a one-year contract extension with Axiom Investors, LLC for management of an active non-U.S. emerging markets growth equities portfolio.
2. Authorize the General Manager to approve and execute the necessary documents, subject to satisfactory business and legal terms.

Discussion

On October 12, 2021, the Committee considered the attached staff report (Attachment 1) recommending a one-year contract extension with Axiom Investors, LLC (Axiom). The Board hired Axiom through the 2013 Active Emerging Market Growth Equities manager search and authorized a three-year contract on July 23, 2013. The contract became effective on January 1, 2014; the current contract extension expires on December 31, 2021. Since inception, LACERS has paid Axiom a total of \$16.9 million in investment management fees as of June 30, 2021. As of September 30, 2021, LACERS' portfolio was valued at \$401 million. Axiom is currently on "On Watch" status through October 1, 2022 due to a benchmark change and two organizational changes. Please refer to Attachment 1 for further details on the history of Axiom's watch status.

The Committee inquired about potential actions at the end of the watch period. Staff explained that if Axiom is unable to achieve outperformance relative to the MSCI Emerging Markets Index since the benchmark change date of August 1, 2020, staff may return to the Committee with possible recommendations to terminate the contract and either conduct a search for a replacement active manager or move the assets to a passive strategy. Based on the discussion and responses by staff,

the Committee concurred with the recommendation by staff and NEPC, LLC, LACERS' General Fund Consultant.

Strategic Plan Impact Statement

A contract extension with Axiom will allow the fund to maintain a diversified exposure to non-U.S. emerging markets growth equities, which is expected to help optimize long-term risk adjusted investment returns (Goal IV). The discussion of the investment manager's profile, strategy, performance, and management fee structure is consistent with Goal V (uphold good governance practices which affirm transparency, accountability, and fiduciary duty).

Prepared By: Ellen Chen, Investment Officer I, Investment Division

RJ/BF/EC:rm

Attachments: 1. Investment Committee Recommendation Report dated October 12, 2021
2. Proposed Resolution



LACERS
LA CITY EMPLOYEES'
RETIREMENT SYSTEM



REPORT TO INVESTMENT COMMITTEE
From: Neil M. Guglielmo, General Manager

MEETING: OCTOBER 12, 2021
ITEM: VI

Neil M. Guglielmo

SUBJECT: INVESTMENT MANAGER CONTRACT WITH AXIOM INVESTORS, LLC REGARDING THE MANAGEMENT OF AN ACTIVE NON-U.S. EMERGING MARKETS GROWTH EQUITIES PORTFOLIO AND POSSIBLE COMMITTEE ACTION

ACTION: CLOSED: CONSENT: RECEIVE & FILE:

Recommendation

That the Committee recommend to the Board a one-year contract extension with Axiom Investors, LLC for management of an active non-U.S. emerging markets growth equities portfolio.

Executive Summary

Axiom Investors, LLC (Axiom) has managed an active non-U.S. emerging markets growth equities portfolio for LACERS since April 2014. LACERS' portfolio is currently valued at \$401 million as of September 30, 2021. Axiom was initially placed on "On Watch" status for performance effective April 17, 2019. Axiom's watch status was subsequently extended on various dates due to a change of the benchmark from the MSCI Emerging Markets Growth (MSCI EM Growth) Index to the MSCI Emerging Markets (MSCI EM) Index, the departure of Christopher Lively, Co-lead Portfolio Manager, and the pending departure of Kurt Polk, President. The firm's current watch status expires on October 1, 2022. In light of Axiom's continued "On Watch" status and consistent with the LACERS Manager Monitoring Policy (Policy), staff and LACERS' General Consultant, NEPC, LLC (NEPC) recommend a one-year contract extension and will continue to monitor the organization and performance of the strategy.

Discussion

Background

Axiom has managed an active non-U.S. emerging markets growth equities portfolio for LACERS since April 2014, and is benchmarked against the MSCI EM Index. Axiom uses a fundamental research-based investment strategy that focuses on companies exhibiting key growth drivers, such as company-specific improvements and favorable macroeconomic and political factors. Such drivers tend to be indicators of positive company financial and stock price performance. The 13 person investment team is led by four Co-lead Portfolio Managers: Andrew Jacobson, Chief Executive Officer and Chief Investment Officer (33 years of experience), Donald Elefson, CFA (38 years of experience), Jose Morales, CFA (32 years of experience) and Young Kim (22 years of experience).

The Board hired Axiom through the 2013 Active Emerging Market Growth Equities manager search process and authorized a three-year contract on July 23, 2013; the contract became effective on January 1, 2014. Axiom was awarded a three-year contract renewal on September 27, 2016, a one-year extension on July 23, 2019, and a one-year extension on July 28, 2020. The current contract expires on December 31, 2021. Axiom has been on “On Watch” status since April 17, 2019 for performance and organizational reasons as discussed in the Due Diligence and Performance sections of this report.

Organization

Axiom is 100% employee-owned, with 57 employees, and is headquartered in Greenwich, Connecticut. As of September 30, 2021, Axiom managed over \$19 billion in total assets with \$8 billion in the emerging markets growth equities strategy.

Due Diligence

Axiom’s investment philosophy, strategy, and process have not changed over the one-year contract extension period. Axiom was initially placed on “On Watch” status for performance on April 17, 2019. After conducting a thorough review of Axiom’s underperformance relative to its benchmark in place at the time, the MSCI EM Growth Index, staff and NEPC determined that the MSCI EM Growth Index had become increasingly concentrated in a few stocks since inception of LACERS’ account and that the benchmark was no longer an effective measure by which to compare Axiom’s strategy. On July 28, 2020, the Board approved a change of Axiom’s benchmark from the MSCI EM Growth Index to the more diversified MSCI EM Index with the condition that Axiom remain on watch through August 1, 2021 in order to monitor Axiom for consistency with its stated strategy. The benchmark change became effective on August 1, 2020.

Subsequently, two material organizational changes at Axiom led to further extensions of Axiom’s watch status. First, on September 29, 2020, Axiom announced that Chris Lively would be stepping down from his role as co-lead portfolio manager of the emerging markets growth equities strategy for personal reasons, triggering an extension of Axiom’s existing watch status to October 1, 2021. Andrew Jacobson, Axiom’s founder, CEO and CIO, and the original architect of the strategy, replaced Mr. Lively as co-lead of the strategy alongside Donald Elefson and Jose Morales. In addition, Axiom hired Young Kim in March 2021 as a fourth co-lead portfolio manager to expand the team’s capabilities.

Second, on August 18, 2021, Axiom announced that Kurt Polk, Axiom’s President, would be leaving the firm at the end of the year for personal reasons, triggering a further extension of Axiom’s existing watch status to October 1, 2022. Axiom will not be filling the vacancy; the existing management committee will assume Mr. Polk’s responsibilities. Currently, the management committee consists of the following members: Edward Azimi, Chief Operating Officer; Lindsay Chamberlain, Managing Director of Client Service and Marketing; Jonathan Ellis, Director of Research and Portfolio Manager; Andrew Jacobson, CEO and CIO; Kurt Polk, President (departing firm); and Denise Zambardi, Senior Vice President and Chief Compliance Officer and Controller.

After conducting due diligence on these matters, staff and NEPC do not anticipate these organizational changes to have a material adverse impact to the management of the investment strategy and LACERS assets. However, staff and NEPC will continue to monitor Axiom closely through the expiration of the “On Watch” status on October 1, 2022.

Performance

As discussed in the Due Diligence section, Axiom’s benchmark was changed from the MSCI EM Growth Index to the MSCI EM Index effective August 1, 2020. Since the effective date of the benchmark change, Axiom’s performance has matched the performance of the MSCI EM Index as presented in the following table. The benchmark change has not resulted in any changes to Axiom’s investment process; Axiom continues to manage the strategy according to the same growth oriented investment philosophy and process in place at the time of hire.

Annualized Performance as of 9/30/21 (Unaudited and Net-of-Fees)			
	3-Month	1-Year	Since 8/1/2020
Axiom	-7.79	17.90	14.95
MSCI EM Index	-8.09	18.20	14.96
<i>% of Excess Return</i>	<i>0.30</i>	<i>-0.30</i>	<i>-0.01</i>

The following table presents Axiom’s performance since inception of the account on April 11, 2014 relative to a blended benchmark that incorporates the performance of the previous MSCI EM Growth Index from account inception date to July 31, 2020 and the performance of the MSCI EM Index from August 1, 2020 to September 30, 2021. Axiom’s underperformance over the two-year, three-year, five-year, and since inception time periods is due to the high stock concentration of the former MSCI EM Growth benchmark and LACERS’ investment guideline limitations that required Axiom’s portfolio to be more diversified than the former benchmark. Please refer to July 28, 2020 report to the Board (Attachment 1) for a detailed discussion of Axiom’s underperformance relative to the MSCI EM Growth Index. The current benchmark, the MSCI EM Index, as presented in the preceding table, is a more appropriate measure of Axiom’s performance in light of portfolio diversification requirements.

Annualized Performance as of 9/30/21 (Unaudited and Net-of-Fees)						
	3-Month	1-Year	2-Year	3-Year	5-Year	Since Inception
Axiom	-7.79	17.90	20.27	13.48	11.73	7.61
Axiom Blended Benchmark*	-8.09	18.20	21.74	14.40	12.70	8.38
<i>% of Excess Return</i>	<i>0.30</i>	<i>-0.30</i>	<i>-1.47</i>	<i>-0.92</i>	<i>-0.97</i>	<i>-0.77</i>

*Axiom Blended Benchmark incorporates MSCI EM Growth Index returns prior to August 1, 2020 and MSCI EM Index returns from August 1, 2020 to present.

Calendar year performance is presented in the table below as supplemental information.

Calendar Year Performance as of 9/30/21 (Net-of-Fees)							
	2020	2019	2018	2017	2016	2015	4/11/14-12/31/14
Axiom	32.46	24.70	-17.64	40.56	8.40	-12.44	-2.01
Axiom Blended Benchmark	32.02	25.10	-18.26	46.80	7.59	-11.34	-2.24
<i>% of Excess Return</i>	<i>0.44</i>	<i>-0.40</i>	<i>0.62</i>	<i>-6.24</i>	<i>0.81</i>	<i>-1.10</i>	<i>0.23</i>

Additionally, as presented on page four of the attached NEPC report (Attachment 2), Axiom’s performance ranks in the top quartile of peers in the eVestment Global Emerging Markets All Cap Growth Equity Universe over the three-year, five-year, and since inception time periods. Relative to the MSCI EM Index benchmark and the peer universe, Axiom’s performance does not currently trigger the performance criteria of the LACERS Manager Monitoring Policy. However, staff recognizes that Axiom’s strategy has returned index-like performance since the date of the benchmark change (August 1, 2020) and the firm remains on “On Watch” status through October 1, 2022. Upon expiration of the watch period, should Axiom be unable to achieve outperformance relative to the MSCI EM Index since the benchmark change date, staff may return to the Committee with a possible recommendation for contract termination.

Fees

LACERS pays Axiom an effective fee of 62 basis points (0.62%), which is approximately \$2.5 million annually based on the value of LACERS’ assets as of September 30, 2021. This fee ranks in the 25th percentile among its peers in the eVestment Global Emerging Markets All Cap Growth Equity Universe (i.e. Axiom’s fee is lower than 75% of peers). Since inception, LACERS has paid Axiom a total of \$16.9 million in investment manager fees as of June 30, 2021.

General Fund Consultant Opinion

NEPC concurs with these recommendations.

Strategic Plan Impact Statement

A contract extension with Axiom will allow the fund to maintain a diversified exposure to the non-U.S. equities emerging markets, which is expected to help optimize long-term risk adjusted investment returns (Goal IV). The discussion of the investment manager’s profile, strategy, performance, and management fee structure are consistent with Goal V (uphold good governance practices which affirm transparency, accountability, and fiduciary duty).

Prepared by: Ellen Chen, Investment Officer I, Investment Division

RJ/BF/EC

- Attachments: 1. Report to Board of Administration Dated July 28, 2020
 2. Consultant Recommendation – NEPC, LLC



LACERS
LOS ANGELES CITY EMPLOYEES'
RETIREMENT SYSTEM



REPORT TO BOARD OF ADMINISTRATION

From: Investment Committee
Sung Won Sohn, Chair
Elizabeth Lee
Nilza R. Serrano

MEETING: JULY 28, 2020
ITEM: X – C

SUBJECT: INVESTMENT MANAGER CONTRACT WITH AXIOM INTERNATIONAL INVESTORS, LLC REGARDING THE MANAGEMENT OF AN ACTIVE EMERGING MARKETS GROWTH EQUITIES PORTFOLIO AND POSSIBLE BOARD ACTION

ACTION: CLOSED: CONSENT: RECEIVE & FILE:

Recommendation

That the Board:

1. Approve a change in Axiom International Investors, LLC's benchmark from the MSCI Emerging Markets Growth Index to the MSCI Emerging Markets Index.
2. Approve a one-year contract extension with Axiom International Investors, LLC for management of an active emerging markets growth equities portfolio.
3. Authorize the General Manager to approve and execute the necessary documents, subject to satisfactory business and legal terms.

Discussion

On July 14, 2020, the Investment Committee considered the attached staff report (Attachment 1) recommending a benchmark change and a one-year contract extension with Axiom International Investors, LLC (Axiom). Axiom has managed an active emerging markets growth equities portfolio for LACERS since April 2014; the current contract expires on December 31, 2020. As of June 30, 2020, LACERS' portfolio was valued at \$464 million. Axiom is currently on "On Watch" status for underperformance relative to the benchmark, pursuant to the LACERS Manager Monitoring Policy. Based on an analysis presented by staff, Axiom's current benchmark, the MSCI Emerging Markets Growth (MSCI EM Growth) Index, is highly concentrated in three stocks, which collectively represent about 34% of the index; this concentration drives benchmark performance and increases risk. Staff and NEPC, LLC (NEPC) recommend changing the benchmark to a more diversified benchmark, the MSCI

Emerging Markets (MSCI EM) Index. This benchmark would better reflect the risk-return profile of Axiom's strategy as governed by LACERS' investment management guidelines.

The Committee inquired about the history of the MSCI EM Growth Index's concentration as well as Axiom's fees. Based on the discussion and responses by staff and NEPC, the Committee concurs with the staff recommendations. Should the Board approve the benchmark change and the contract extension, staff would implement the benchmark change effective as of close of business on July 31, 2020. Staff and NEPC would also extend Axiom's watch status to July 31, 2021 in order to monitor Axiom for consistency with its stated growth strategy and the portfolio's performance in light of the benchmark change.

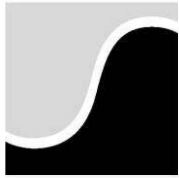
Strategic Plan Impact Statement

A contract extension with Axiom will allow the fund to maintain a diversified exposure to emerging markets growth equities, which is expected to help optimize long-term risk adjusted investment returns (Goal IV). The discussion of the investment manager's profile, strategy, performance, and management fee structure is consistent with Goal V (uphold good governance practices which affirm transparency, accountability, and fiduciary duty).

Prepared By: Ellen Chen, Investment Officer I, Investment Division

RJ/BF/EC:jp

Attachments: 1. Investment Committee Recommendation Report dated July 14, 2020
2. Proposed Resolution



LACERS
LOS ANGELES CITY EMPLOYEES'
RETIREMENT SYSTEM



REPORT TO INVESTMENT COMMITTEE
From: Neil M. Guglielmo, General Manager

MEETING: JULY 14, 2020
ITEM: IV

Neil M. Guglielmo

SUBJECT: INVESTMENT MANAGER CONTRACT WITH AXIOM INTERNATIONAL INVESTORS, LLC REGARDING THE MANAGEMENT OF AN ACTIVE EMERGING MARKETS GROWTH EQUITIES PORTFOLIO AND POSSIBLE COMMITTEE ACTION

ACTION: CLOSED: CONSENT: RECEIVE & FILE:

Recommendation

That the Committee recommend to the Board:

1. A change in Axiom International Investors, LLC's benchmark from the MSCI Emerging Markets Growth Index to the MSCI Emerging Markets Index.
2. A one-year contract extension with Axiom for management of an active emerging markets growth equities portfolio.

Executive Summary

Axiom International Investors, LLC (Axiom) has managed an active emerging markets growth equities portfolio for LACERS since April 2014. LACERS' portfolio is currently valued at \$424 million as of May 31, 2020. Axiom was placed "On Watch" for an initial one-year period effective April 17, 2019 due to performance. Due to a high concentration in three stocks in the existing MSCI Emerging Markets Growth (MSCI EM Growth) Index, which skews benchmark performance and increases risk, staff and NEPC, LLC (NEPC) recommend changing the benchmark to the MSCI Emerging Markets (MSCI EM) Index. In light of Axiom's continued "On Watch" status and consistent with the LACERS Manager Monitoring Policy, staff and NEPC recommend a one-year contract extension.

Discussion

Background

Axiom has managed an active emerging markets growth equities portfolio for LACERS since April 2014, and is benchmarked against the MSCI EM Growth Index. Axiom uses a fundamental research-based investment strategy that focuses on companies exhibiting key growth drivers, such as company-specific improvements and favorable macroeconomic and political factors. Such drivers tend to be indicators of positive company financial and stock price performance. The investment team consists of six

professionals including co-portfolio managers Christopher Lively and Don Elefson, who have 33 and 37 years of experience, respectively.

Axiom was hired through the 2013 Active Emerging Market Growth Equities manager search process and a three-year contract was authorized by the Board on July 23, 2013. Axiom was awarded a contract renewal on September 27, 2016 and a one-year extension on July 23, 2019. The current contract expires on December 31, 2020.

Organization

Axiom is 100% employee-owned, with 50 employees, and is headquartered in Greenwich, Connecticut. As of May 31, 2020, Axiom managed over \$13 billion in total assets with \$5.9 billion in the emerging markets growth equities strategy.

Due Diligence

Axiom’s organizational structure, investment philosophy, strategy, and process have not changed over the one-year contract extension period.

Performance

As of May 31, 2020, Axiom has underperformed the MSCI EM Growth Index over all time periods as presented in the table below.

Annualized Performance as of 5/31/20 (Net-of-Fees)						
	3-Month	1-Year	2-Year	3-Year	5-Year	Since Inception ¹
Axiom	-4.07	4.12	-3.43	2.43	2.73	2.85
MSCI EM Growth Index	-3.42	7.45	-2.67	3.72	3.91	3.84
<i>% of Excess Return</i>	-0.65	-3.33	-0.76	-1.29	-1.18	-0.99

¹Inception Date: 4/11/14

Calendar year performance is presented in the table below as supplemental information.

Calendar Year Performance as of 5/31/20 (Net-of-Fees)							
	1/1/20 - 5/31/20	2019	2018	2017	2016	2015	4/11/14- 12/31/14
Axiom	-11.35	24.70	-17.64	40.56	8.40	-12.44	-2.01
MSCI EM Growth Index	-9.95	25.10	-18.26	46.80	7.59	-11.34	-2.24
<i>% of Excess Return</i>	-1.40	-0.40	0.62	-6.24	0.81	-1.10	0.23

Pursuant to the LACERS Manager Monitoring Policy (Policy), Axiom was placed on “On Watch” status for an initial one-year period effective April 17, 2019. The following Policy watch list criteria triggered the “On Watch” status based on the performance as of March 31, 2019.

1. Annualized net underperformance relative to its benchmark for trailing 3 years.
2. Annualized net underperformance relative to its benchmark for trailing 5 years.
3. Annualized net Information Ratio trailing 5 years relative to its benchmark is below .20.

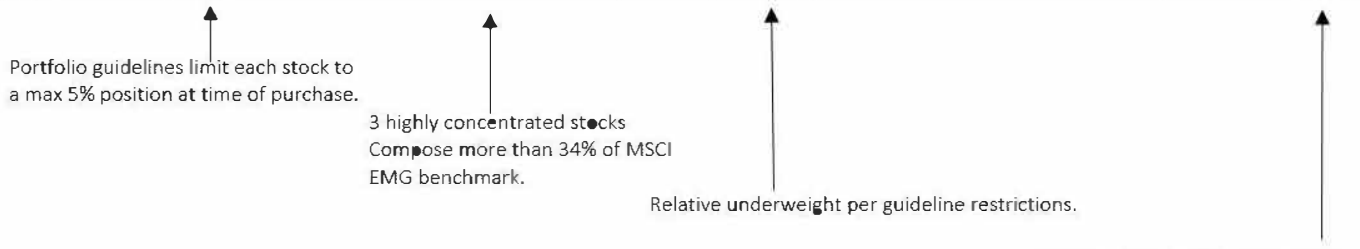
Based on performance as of March 31, 2020, Axiom continued to trigger the same three Policy criteria. Accordingly, staff and NEPC extended Axiom’s “On Watch” status for another one-year period effective April 18, 2020.

Benchmark Concentration and Risk

To further understand Axiom’s underperformance relative to the MSCI EM Growth Index, staff and NEPC conducted an attribution analysis which revealed a high benchmark concentration in three secular growth stocks: Alibaba Group, Tencent, and Taiwan Semiconductor. Of the 551 stocks in the benchmark, these three stocks collectively comprise about a 34% weight in the benchmark and have driven 99% of benchmark’s cumulative three-year performance return (i.e., these stock have produced 11.56% of the benchmark’s 11.63% total return, while the remaining stocks in the index have produced 0.07% of the benchmark return, as presented in the following attribution table). LACERS’ investment management guidelines specifically limit individual stock holdings to 5% of the portfolio’s market value at time of purchase to control risk and ensure sufficient diversification among holdings. This guideline has required Axiom to limit total exposure to Alibaba Group, Tencent, and Taiwan Semiconductor to about half of their current total benchmark weight as illustrated in the table below. As of May 31, 2020, Axiom’s total exposure to these three stocks was about 18% of the portfolio, whereas the same three stocks represented about 34% of the index. Over the time period presented in the table, Axiom’s underweight to these stocks has contributed a -3.73% cumulative excess return relative to the benchmark, which is more than the cumulative portfolio underperformance of -1.54%. Alternatively stated, Axiom’s compliance with LACERS’ guidelines has accounted for all of Axiom’s underperformance relative to the benchmark.

Los Angeles City Employees’ Retirement System vs. MSCI Emerging Markets Growth Attribution of 3 stocks where guideline restriction accounted for more than the overall fund underperformance 3/31/2017-5/31/2020

	LACERS			MSCI EM Growth			Variation			Attribution Analysis		
	Ending Weight	Total Return	Contrib. To Return	Ending Weight	Total Return	Contrib. To Return	Variation in Ending Weight	Total Return Difference	Contrib. To Return Difference	Allocation Effect	Selection + Interaction	Total Effect
Total	100.00	10.10	10.10	100.00	11.63	11.63	—	-1.54	-1.54	-0.21	-1.32	-1.54
Alibaba	6.32	69.46	2.70	14.35	69.35	4.71	-8.03	0.11	-2.01	-1.58	0.00	-1.57
Tencent	6.41	55.32	2.40	11.18	55.39	3.89	-4.77	-0.06	-1.49	-1.30	-0.01	-1.31
Taiwan Semiconductor	5.45	56.92	2.08	8.83	59.25	2.96	-3.37	-2.32	-0.88	-0.54	-0.31	-0.85
Sum	18.18			34.36			-16.17					-3.73



Source: Factset

At the time of Axiom’s hiring in 2014, the MSCI EM Growth Index was sufficiently diversified to be a suitable benchmark by which to gauge Axiom’s performance. The following table illustrates the growing concentration of Alibaba Group, Tencent, and Taiwan Semiconductor in the LACERS account and the MSCI EM Growth Index, since inception of the account.

	6/30/2014	5/31/2020
Axiom LACERS Account	8.89%	18.18%
MSCI EM Growth	15.86%	31.48%

Staff, NEPC, and Axiom agree that the benchmark’s current three stock concentration exposes the benchmark to an imprudent level of risk and that LACERS’ guidelines continue to provide appropriate diversification risk controls for Axiom’s strategy. To properly reflect the risk-return profile of Axiom’s strategy imposed by LACERS guidelines, staff and NEPC recommend changing Axiom’s benchmark to the MSCI Emerging Markets (MSCI EM) Index, a diversified index consisting of 1,403 emerging market stocks (the MSCI EM Growth Index is a subset of this index). Such a change would reduce the benchmark concentration risk; the aforementioned stocks account for only 17% of the MSCI EM Index versus 34% for the MSCI EM Growth benchmark. A benchmark change would have no impact on Axiom’s process for identifying growth stock opportunities. In fact, it would more accurately reflect Axiom’s approach of finding opportunities across a broad range of sectors as Axiom’s process begins with the MSCI EM Index as the universe from which to source ideas. Exhibit 1 of Attachment 1 compares the sector allocations of the LACERS account relative to the MSCI EM and EM Growth Indices.

Comparing Axiom’s performance to the more diversified MSCI EM Index, Axiom has outperformed over all annualized time periods and most calendar year periods as presented in the tables below. Axiom’s performance relative to the MSCI EM Index does not trigger the watch criteria of the Policy.

Annualized Performance as of 5/31/20 (Net-of-Fees)						
	3-Month	1-Year	2-Year	3-Year	5-Year	Since Inception ¹
Axiom	-4.07	4.12	-3.43	2.43	2.73	2.85
MSCI EM Growth Index	-3.42	7.45	-2.67	3.72	3.91	3.84
<i>% of Excess Return</i>	-0.65	-3.33	-0.76	-1.29	-1.18	-0.99
MSCI EM Index	-6.95	-4.39	-6.55	-0.15	0.87	0.98
<i>% of Excess Return</i>	2.88	8.51	3.12	2.58	1.86	1.87

¹Inception Date: 4/11/14

Calendar Year Performance as of 5/31/20 (Net-of-Fees)							
	1/1/20 - 5/31/20	2019	2018	2017	2016	2015	4/11/14-12/31/14
Axiom	-11.35	24.70	-17.64	40.56	8.40	-12.44	-2.01
MSCI EM Growth Index	-9.95	25.10	-18.26	46.80	7.59	-11.34	-2.24
<i>% of Excess Return</i>	<i>-1.40</i>	<i>-0.40</i>	<i>0.62</i>	<i>-6.24</i>	<i>0.81</i>	<i>-1.10</i>	<i>0.23</i>
MSCI EM Index	-15.96	18.42	-14.57	37.28	11.15	-14.92	-3.89
<i>% of Excess Return</i>	<i>4.61</i>	<i>6.28</i>	<i>-3.07</i>	<i>3.28</i>	<i>-2.75</i>	<i>2.48</i>	<i>1.88</i>

Further, with the exception of LACERS, all of Axiom’s Emerging Markets Equity clients use either the MSCI EM Index or a custom index based off the MSCI EM Index. None use the MSCI EM Growth Index due to the concentration issue. As of June 25, 2020, Axiom currently has 11 other public fund clients invested in the strategy, totaling \$2.3 billion in AUM.

Should the Committee and Board approve a benchmark change and contract extension, staff would implement the benchmark change effective as of close of business on July 31, 2020. Staff and NEPC would also extend Axiom’s watch status to July 31, 2021 in order to monitor Axiom for consistency with its stated growth strategy and the portfolio’s performance in light of the benchmark change.

Fees

LACERS pays Axiom an effective fee of 62 basis points (0.62%), which is approximately \$2.6 million annually based on the value of LACERS’ assets as of May 31, 2020. This fee ranks in the 23rd percentile among its peers in the eVestment Global Emerging Markets All Cap Growth Equity Universe (i.e. Axiom’s fee is lower than 77% of peers).

General Fund Consultant Opinion

NEPC concurs with these recommendations.

Strategic Plan Impact Statement

A benchmark change and contract extension with Axiom will allow the fund to maintain a diversified exposure to the non-U.S. equities emerging markets, which is expected to help optimize long-term risk adjusted investment returns (Goal IV). The discussion of the investment manager’s profile, strategy, performance, and management fee structure are consistent with Goal V (uphold good governance practices which affirm transparency, accountability, and fiduciary duty).

Prepared by: Ellen Chen, Investment Officer I, Investment Division

RJ/BF/EC:jp

Attachments: 1. Consultant Recommendation – NEPC, LLC



NEPC, LLC

To: Los Angeles City Employees' Retirement System Investment Committee

From: NEPC, LLC

Date: July 14, 2020

Subject: Axiom Investors - Contract extension and benchmark change

Recommendation

NEPC recommends the Los Angeles City Employees' Retirement System ('LACERS') change the portfolio's benchmark to the MSCI Emerging Markets Index from the MSCI Emerging Markets Growth Index. NEPC also recommends that LACERS extend the contract that is currently in place with Axiom Investors ('Axiom') for a period of one year from the date of contract expiry.

Background

Axiom was hired on April 11, 2014 to provide the Plan with public equity exposure across emerging markets. The portfolio's strategy is benchmarked against the MSCI Emerging Markets Growth Index and has a performance inception date of May 1, 2014.

As of May 31, 2020, Axiom managed \$424.3 million, or 2.4% of Plan assets in an international emerging markets separately managed account. The performance objective is to outperform the benchmark, net of fees, annualized over a full market cycle (normally three-to-five years). The account is currently on Watch due to performance under the LACERS' Manager Monitoring Policy.

Axiom has requested a benchmark change from the MSCI Emerging Markets Growth Index to the broader MSCI Emerging Markets Index. Axiom lists the preferred benchmark for the portfolio as the broader MSCI Emerging Markets Index and uses the broader index as the starting point in constructing the portfolio. Axiom's investment process identifies stocks based on positive earnings growth, positive earnings estimate revisions, positive price movement and favorable valuation characteristics which results in a 'growth' oriented portfolio.

As of March 31, 2020, Axiom's portfolio weights compared to the MSCI Emerging Markets Index and the MSCI Emerging Markets Growth Index are shown in Exhibit 1 below.



Exhibit 1

GICS Sector	Portfolio Weight	MSCI EM Index	Excess Weight	MSCI EM Growth Index Weight	Excess Weight
Energy	6.7%	7.4%	-0.7%	2.5%	4.2%
Materials	3.7%	7.3%	-3.7%	4.2%	-0.5%
Industrials	6.2%	5.3%	0.9%	4.6%	1.5%
Consumer Discretionary	16.6%	14.3%	2.3%	22.0%	-5.4%
Consumer Staples	7.4%	6.2%	1.2%	9.3%	-1.8%
Health Care	2.6%	2.7%	-0.1%	3.9%	-1.4%
Financials	24.5%	24.5%	0.0%	14.9%	9.7%
Information Technology	20.0%	15.6%	4.3%	20.4%	-0.4%
Communication Services	10.2%	11.0%	-0.8%	14.9%	-4.8%
Utilities	0.0%	2.6%	-2.6%	2.0%	-2.0%
Real Estate	2.0%	3.0%	-1.0%	1.4%	0.6%
Unclassified	0.2%	0.0%	0.2%	0.0%	0.2%

When Axiom was hired, the MSCI Emerging Markets Growth index was much less concentrated than it is today and therefore it was more acceptable as a performance benchmark for the Axiom portfolio. To demonstrate how the benchmark has changed over time, Exhibit 2 provides a list of the top ten names in the MSCI Emerging Markets Growth at the time LACERS hired Axiom versus today. As of 3/31/2014, the top ten names in the index represented 27% of the total index, while as of April 30, 2020 the top ten names represented 44.5% of the index. In comparison, the concentration in the top ten names in the broader index for similar time periods was 16.4% and 28.1%.

We first started discussing the concentration in the benchmark with Axiom in 2017. Given that the concentration in the growth index has become much worse and our belief that the restriction in LACERS' investment guidelines (i.e., maximum amount in any one stock to be less than 5%) should remain in place to ensure reasonable diversification, we believe that a benchmark change is warranted for the portfolio. We do not believe that Axiom will change their investment style just because the benchmark is different.

Exhibit 2:

31-Mar-14		April 30 2020	
Asset Name	Weight (%)	Asset Name	Weight (%)
SAMSUNG ELECTRONICS CO LTD	7.26%	ALIBABA GROUP HOLDING	12.47%
TAIWAN SEMICONDUCTOR MANU	4.99%	TENCENT HOLDINGS LTD	10.92%
TENCENT HOLDINGS LTD	3.70%	TAIWAN SEMICONDUCTOR MANUFACT (8.93%
NASPERS	2.27%	SAMSUNG ELECTRONICS CO LTD	4.51%
ITAU UNIBANCO HOLDING SA	1.96%	NASPERS	2.49%
AMBEV SA	1.84%	SK HYNIX INC	1.33%
CNOOC LTD	1.40%	JD.COM INC	1.13%
SBERBANK ROSSII PAO	1.34%	SBERBANK ROSSII PAO	1.02%
HOUSING DEVELOPMENT FINANCE	1.14%	NETEASE INC	0.87%
CHINA LIFE INSURANCE CO LTD	1.10%	ICICI BANK LTD	0.86%



We believe that by changing Axiom's benchmark, you will have a benchmark that is fair and not overly concentrated in a few names. Additionally, Axiom will have the ability to express a positive view on a large benchmark-weighted name and remain in-line with LACERS' guidelines. Some of the drawbacks of continuing to use the growth benchmark is that Axiom's performance relative to the benchmark will be primarily determined by the performance of a handful of names (i.e., Alibaba Group, Tencent, and Taiwan Semiconductor). There may be times when there is meaningful dispersion in the Axiom portfolio versus the benchmark and it will have nothing to do with Axiom's skill as an investment manager and everything to do with poor benchmark construction. To our knowledge, LACERS is the only client who has requested that Axiom use the growth version of the emerging markets benchmark. We do not want the firm to manage your account any differently than how they manage their other clients' portfolios.

Axiom is an independent employee-owned investment management firm founded in 1998 by Andrew Jacobson. As of March 31, 2020 the firm had \$11.1 billion in assets under management and had 50 employees. Prior to forming Axiom, the investment team was responsible for developing and managing the international equity strategy at Columbus Circle Investors, a division of PIMCO Advisors LP. The Axiom Emerging Markets team is led by Chris Lively and co-portfolio manager Donald Elefson. José Morales joined the firm in 2017 as a portfolio manager. The portfolio managers split the emerging markets by region. Chris Lively retains final buy and sell authority, and ultimately decides portfolio positioning and stock weightings. The team also leverages a shared research platform across all of Axiom's non-U.S. equity products.

The Axiom investment philosophy is to invest in quality companies that are growing and evolving better and more rapidly than expected. Critical to the investment process is the ability to identify these changes in growth, prior to them being reflected in expectations or market valuations. Axiom employs a bottom-up, growth-oriented investment discipline that relies on detailed fundamental stock analysis to identify companies that are improving more quickly than generally expected. The primary emphasis is to isolate those companies that are likely to exceed expectations, which they do by identifying and monitoring the key business drivers of each stock. Key business drivers are essentially the leading indicators of stock price performance. Key drivers can include company specific, industry, macroeconomic and political factors. For each of these drivers, they survey a wide variety of sources to determine investor expectations.

The universe is defined as securities that have a minimum market cap of \$1.0 billion, are covered by 1 or more brokerage analysts and have liquidity of over \$5 MM/day. About 80% of Axiom's new ideas are typically identified as a consequence of specific, positive, fundamental developments in a company's operations (e.g., favorable sales of a new product, a significant restructuring initiative or a change in industry conditions). Axiom also screens the investment universe on a variety of financial and technical factors to help identify new ideas for further detailed fundamental analysis. These factors include positive earnings growth, positive earnings estimate revisions, positive price movement and favorable valuation characteristics.



Performance

Referring to Exhibit 3, as of May 31, 2020, since the portfolio's inception date of May 1, 2014, the portfolio has underperformed its benchmark by 1.10% (3.11% vs 4.21%). Over the past year, ended May 31, 2020, the portfolio has underperformed the benchmark by 3.33% (4.12% vs. 7.45%). Referring to Exhibit 4, since inception of the Axiom portfolio ended March 31, 2020, the portfolio ranked in the 18th percentile among its peers and underperformed the benchmark by 1.21%. In the trailing one-year ended March 31, 2020, the portfolio ranked in the 8th percentile in its peer group underperforming its benchmark by 1.35%. Since inception, ended March 31, 2020, the information ratio was -0.47 and active risk, as measured by tracking error was 2.56%. Please note that the portfolio's performance exceeds the broader emerging market index for time periods ending March 31, 2020.

Referring to Exhibit 5, since inception, historical cumulative performance has been negative when compared to the growth benchmark. Security selection in the Information Technology, Industrials and Communication Services sectors have been responsible for cumulative negative returns since the first quarter of 2017. Referring to Exhibit 6, Axiom's style box analysis, since inception ending March 31, 2020, reveals that the portfolio is aligned closer to a core portfolio than to a Growth portfolio. This is not surprising given the diversification of the Axiom portfolio and the concentration in names in the MSCI Emerging Markets Growth Index.

Fees

The portfolio has an asset-based fee of 0.62% annually. This fee ranks in the 23rd percentile among its peers in the eVestment Global Emerging Markets All Cap Growth Equity Universe. In other words, 77% of the 48 products included in the peer universe have a higher fee than the LACERS account.

Conclusion

As of this writing, Axiom has struggled to outperform the MSCI Emerging Markets Growth benchmark over all trailing periods. Much of the underperformance can be attributed to their investment process and focus on diversification versus what has become a significantly concentrated style benchmark since March 31, 2014. We believe in the long-term efficacy of a strategy that focuses on understanding the business fundamentals of companies that are growing faster than markets anticipate. NEPC recommends changing Axiom's benchmark to the MSCI Emerging Markets Index from the MSCI Emerging Markets Growth Index. In addition, NEPC recommends a contract extension for a period of one-year from the period of contract expiry.

The following tables provide specific performance information, net of fees referenced above.

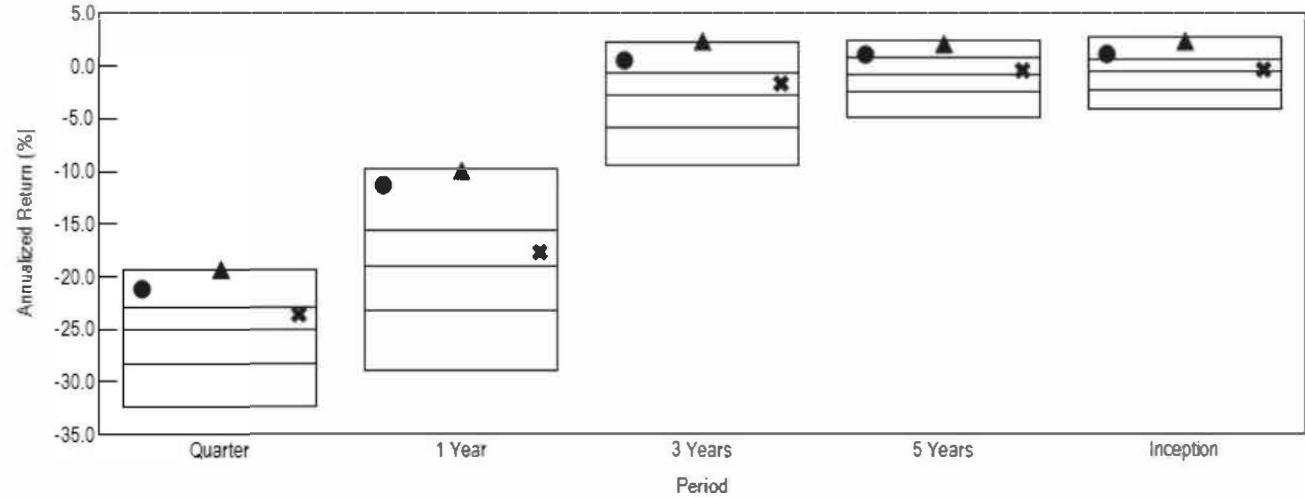
Exhibit 3

	Ending May 31, 2020										
	Market Value(\$)	1 Mo(%)	3 Mo(%)	YTD(%)	Fiscal YTD(%)	1 Yr(%)	3 Yrs(%)	5 Yrs(%)	10 Yrs(%)	Inception (%)	Inception Date
Axiom Emerging Markets	424,319,079	2.43	-4.07	-11.51	-2.87	4.12	2.43	2.73	--	3.11	14-May
MSCI Emerging Markets Growth NR USD		1.72	-3.42	-9.95	0.28	7.45	3.72	3.91	4.8	4.21	14-May
MSCI Emerging Markets		0.77	-6.95	-15.96	-10	-4.39	-0.15	0.88	2.47	1.29	14-May



Exhibit 4

eV Emg Mkts Equity Net Return Comparison
Ending March 31, 2020



	Return (Rank)					
	Quarter	1 Year	3 Years	5 Years	Inception	
5th Percentile	-19.31	-9.69	2.27	2.46	2.72	
25th Percentile	-22.92	-15.55	-0.69	0.76	0.61	
Median	-25.05	-19.10	-2.71	-0.87	-0.53	
75th Percentile	-28.34	-23.21	-5.77	-2.36	-2.26	
95th Percentile	-32.37	-29.04	-9.44	-4.79	-4.00	
# of Portfolios	224	222	198	173	159	
● Axiom Emerging Markets	-21.17 (12)	-11.29 (8)	0.59 (16)	1.14 (22)	1.20 (18)	
▲ MSCI Emerging Markets Growth NR USD	-19.34 (6)	-9.94 (5)	2.39 (5)	2.13 (10)	2.41 (8)	
× MSCI Emerging Markets	-23.60 (35)	-17.69 (40)	-1.62 (32)	-0.37 (41)	-0.29 (46)	



Exhibit 5

Quarterly and Cumulative Excess Performance

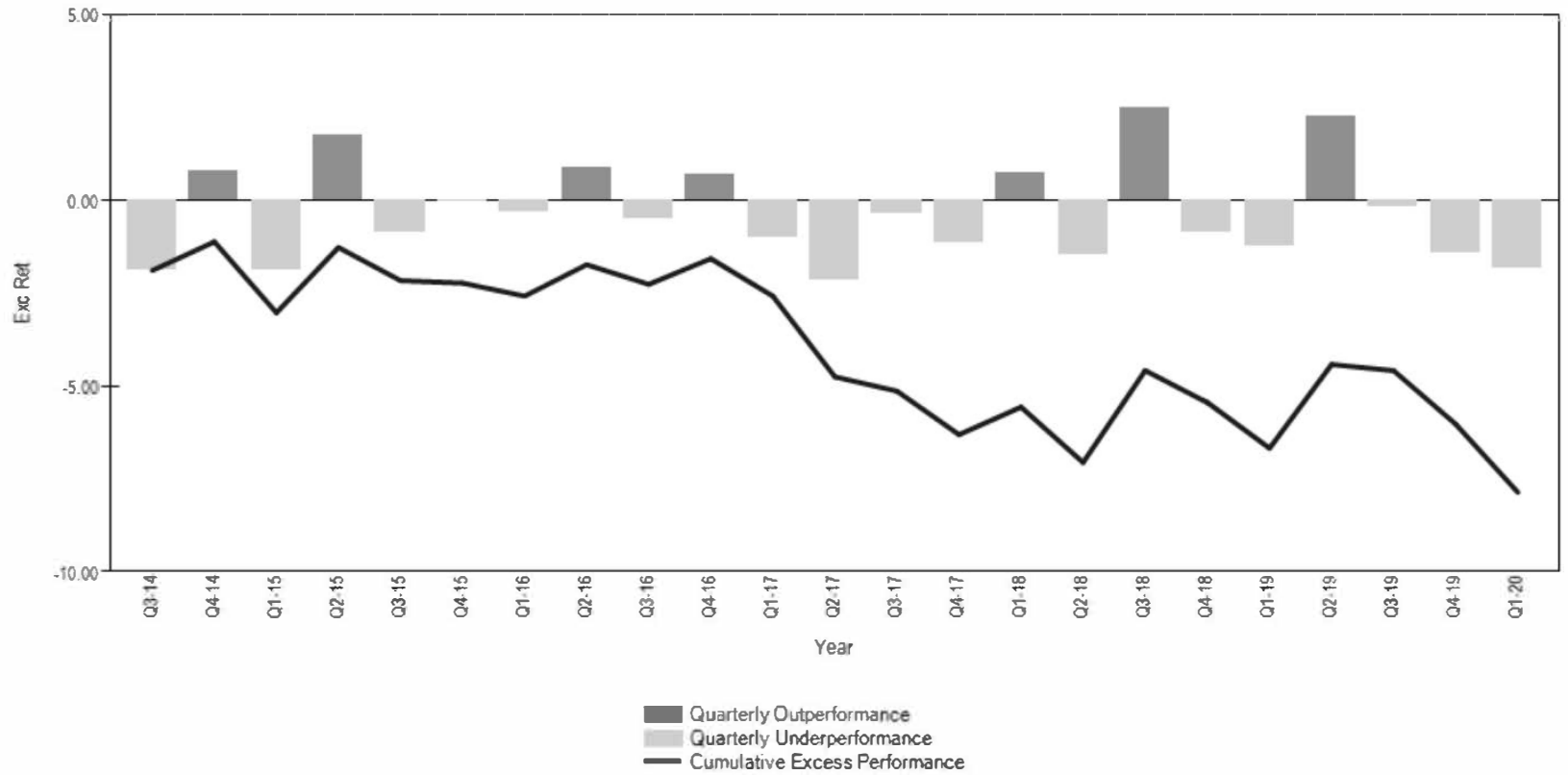
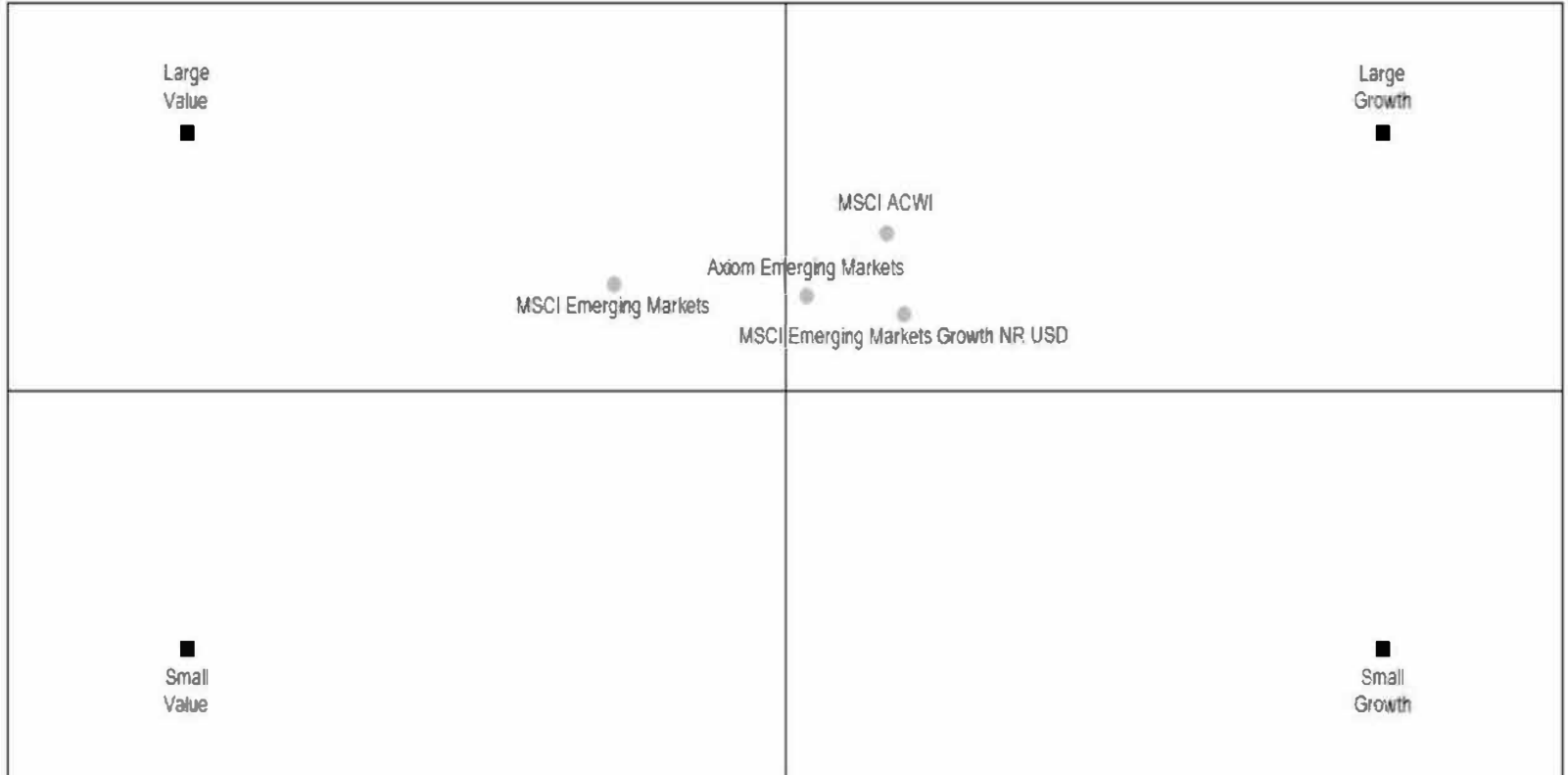


Exhibit 6

Non U.S. Effective Style Map vs. EAFE
5 Years 11 Months Ending March 31, 2020



CONTRACT EXTENSION
AXIOM INTERNATIONAL INVESTORS, LLC
ACTIVE EMERGING MARKETS GROWTH EQUITIES
PORTFOLIO MANAGEMENT

PROPOSED RESOLUTION

WHEREAS, LACERS' current one-year contract extension with Axiom International Investors, LLC (Axiom) for active emerging markets growth equities portfolio management expires on December 31, 2020; and,

WHEREAS, Axiom is currently "On Watch" for performance pursuant to the LACERS Manager Monitoring Policy; and,

WHEREAS, Axiom's current benchmark, the MSCI Emerging Markets Growth Index, is concentrated in three stocks and does not properly reflect the diversification and risk-return profile of Axiom's strategy, as governed by LACERS' investment management guidelines; and,

WHEREAS, the MSCI Emerging Markets Index will serve as a more suitable benchmark by which to measure Axiom's performance and risk; and,

WHEREAS, a one-year contract extension will provide the necessary time to evaluate Axiom for consistency with its stated growth strategy relative to a new benchmark; and,

WHEREAS, on July 28, 2020, the Board approved the Investment Committee's recommendations to approve a one-year contract extension with Axiom and to approve a benchmark change to the MSCI Emerging Market Index effective end of business day July 31, 2020.

NOW, THEREFORE, BE IT RESOLVED, that the General Manager is hereby authorized to approve and execute a contract subject to satisfactory business and legal terms and consistent with the following services and terms:

<u>Company Name:</u>	Axiom International Investors, LLC
<u>Service Provided:</u>	Active Emerging Markets Growth Equities Portfolio Management
<u>Effective Dates:</u>	January 1, 2021 through December 31, 2021
<u>Duration:</u>	One year
<u>Benchmark:</u>	MSCI Emerging Markets Index
<u>Allocation as of June 30, 2020:</u>	\$464 million

July 28, 2020



To: Los Angeles City Employees' Retirement System Investment Committee

From: NEPC, LLC

Date: October 12, 2021

Subject: Axiom Investors - Contract Extension

Recommendation

NEPC recommends the Los Angeles City Employees' Retirement System ('LACERS') extend the contract with Axiom Investors ('Axiom') for a period of one year from the date of contract expiry.

Background

Axiom was hired on April 11, 2014 to provide the Plan with public equity exposure to emerging markets. The portfolio's strategy is benchmarked against the MSCI Emerging Markets Index and has a performance inception date of May 1, 2014. As of July 31, 2021, Axiom managed \$410.1 million, or 1.8% of Plan assets in a separately managed account. The performance objective is to outperform the benchmark, net of fees, annualized over a full market cycle (normally three-to-five years). The account is currently on Watch pursuant to the LACERS Manager Monitoring Policy due to the departure of the lead Portfolio Manager in late 2020 as well as a benchmark change.

Axiom's Watch status is a reflection of the changes experienced at the firm as well as the changes to the investment product's benchmark. Recall, that the lead portfolio manager left the firm for medical reasons in late 2020 and was replaced by the firm's Chief Investment Officer, Andrew Jacobson, who re-joined the portfolio management team. Mr. Jacobson was the original architect of the strategy and NEPC was comfortable with the transition given the circumstances. The firm also hired a co-Portfolio manager into the emerging markets team in the first quarter of 2021. In the third quarter of 2021, Kurt Polk, Axiom's President, announced his intention to resign from the firm. His final day will be December 31, 2021. Axiom was founded in Connecticut and Founder, CEO and CIO Andrew Jacobson strongly stands by the structure he implemented with one firm/team in one central location that promotes collaboration. Kurt joined Axiom in 2014 and was one of the 23 equity partners. Upon his departure, he will be selling back his equity stake to the firm at book value.

Additionally, Axiom requested a benchmark change from the MSCI Emerging Markets Growth Index to the broader MSCI Emerging Markets Index in July, 2020. The benchmark change request was granted given the growing level of concentration observed over time in the MSCI Emerging Markets Growth Index; the top 10 names made up 44.5% of the index as of April, 2020. As of August, 2021, the top 10 names made up 40.3% of the index. NEPC recommended granting the change on the basis that we believed the benchmark change would not result in a change in the portfolio's style or strategy. We continue with this belief today.

Axiom is an independent employee-owned investment management firm founded in 1998 by Andrew Jacobson. As of June 30, 2021 the firm had \$19.84 billion in assets under management and had 56 employees. Prior to forming Axiom, the investment team was responsible for developing and managing the international equity strategy at Columbus Circle Investors, a division of PIMCO

Advisors LP. The Axiom Emerging Markets team is currently co-led by Andrew Jacobson with three co-Portfolio Managers. Don Elefson and Jose Gerardo Morales have been on the team overseeing the EME strategy since 2012 and 2017 respectively. Young Kim joined the emerging markets team as co-Portfolio manager in the first quarter of 2021. Mr. Kim joined Axiom from Columbia Threadneedle and relocated from Portland, Oregon since Axiom believes in having all team members in one place. Mr. Kim was a co-Portfolio Manager on the Emerging Markets Equity strategy at Columbia Threadneedle which is also 1-rated strategy at NEPC. The portfolio managers split the emerging markets by region and also leverage a shared research platform across all of Axiom's non-U.S. equity products.

The Axiom investment philosophy is to invest in quality companies that are growing and evolving better and more rapidly than expected. Critical to the investment process is the ability to identify these changes in growth, prior to them being reflected in expectations or market valuations. Axiom employs a bottom-up, growth-oriented investment discipline that relies on detailed fundamental stock analysis to identify companies that are improving more quickly than generally expected. The primary emphasis is to isolate those companies that are likely to exceed expectations, which they do by identifying and monitoring the key business drivers of each stock. Key business drivers are essentially the leading indicators of stock price performance. Key drivers can include company specific, industry, macroeconomic and political factors. For each of these drivers, they survey a wide variety of sources to determine investor expectations.

The universe is defined as securities that have a minimum market cap of \$1.0 billion, are covered by 1 or more brokerage analysts and have liquidity of over \$5 MM/day. About 80% of Axiom's new ideas are typically identified as a consequence of specific, positive, fundamental developments in a company's operations (e.g., favorable sales of a new product, a significant restructuring initiative or a change in industry conditions). Axiom also screens the investment universe on a variety of financial and technical factors to help identify new ideas for further detailed fundamental analysis. These factors include positive earnings growth, positive earnings estimate revisions, positive price movement and favorable valuation characteristics.

Performance

Referring to Exhibit 1, as of July 31, 2021, since the portfolio's inception date of May 1, 2014, the portfolio has outperformed its benchmark by 2.40% (8.40% vs 2.40%). Over the past year, ended July 31, 2021, the portfolio has outperformed the benchmark by 3.04% (23.68% vs. 20.64%). Referring to Exhibit 2 and comparing the portfolio to its peer group, since inception of the Axiom portfolio ended June 30, 2021, the portfolio ranked in the 21st percentile among its peers and outperformed the benchmark by 2.29%. In the trailing one-year ended June 30, 2021, the portfolio ranked in the 45th percentile in its peer group outperforming its benchmark by 3.49%. Since inception, ended July 31, 2021, the information ratio was 0.76 and active risk, as measured by tracking error was 3.19%.

Referring to Exhibit 2, since inception, the portfolio has added value against its benchmark as the historical cumulative performance has been strongly positive over the past two years. The positive performance is primarily due to the portfolio's focus on growthy stocks in a period of time when growth stocks have been rewarded.



Fees

The portfolio has an asset-based fee of 0.62% annually. This fee ranks in the 25th percentile among its peers in the eVestment All Emerging Markets Equity Universe. In other words, 75% of the 421 products included in the peer universe have a higher fee than the LACERS account.

Conclusion

Axiom has had some turnover in senior-level investment decision making roles and we believe that an ongoing Watch diligence status is warranted. The portfolio has outperformed the MSCI Emerging Markets Index over most trailing periods and importantly has added significant value since inception over the benchmark. NEPC continues to be a believer in the long-term efficacy of this strategy that focuses on understanding business fundamentals of companies that are growing faster than markets anticipate. NEPC recommends a contract extension for a period of one-year from the period of contract expiry and for the firm to remain on Watch status.

The following tables provide specific performance information, net of fees referenced above.

Exhibit 1: Net of Fee Performance

	Ending July 31, 2021							
	Market Value(\$)	3 Mo(%)	YTD(%)	1 Yr(%)	3 Yrs(%)	5 Yrs(%)	Inception(%)	Inception Date
Axiom Emerging Markets	410,107,713	-2.64	-0.47	23.68	12.49	13.08	8.40	14-May
MSCI Emerging Markets		-4.40	0.22	20.64	7.93	10.37	6.00	14-May
<i>Excess</i>		<i>1.76</i>	<i>-0.69</i>	<i>3.04</i>	<i>4.56</i>	<i>2.71</i>	<i>2.40</i>	





Exhibit 2: Universe Comparison Net of Fees

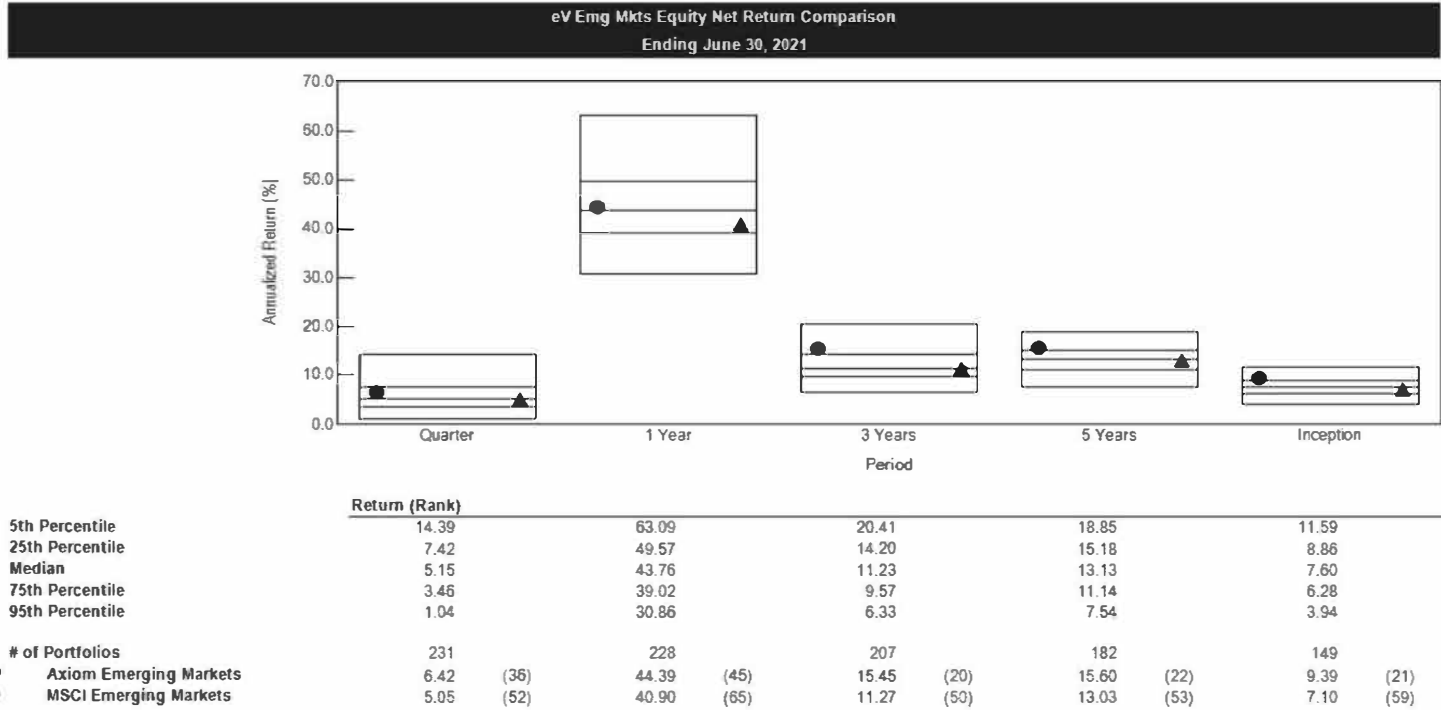
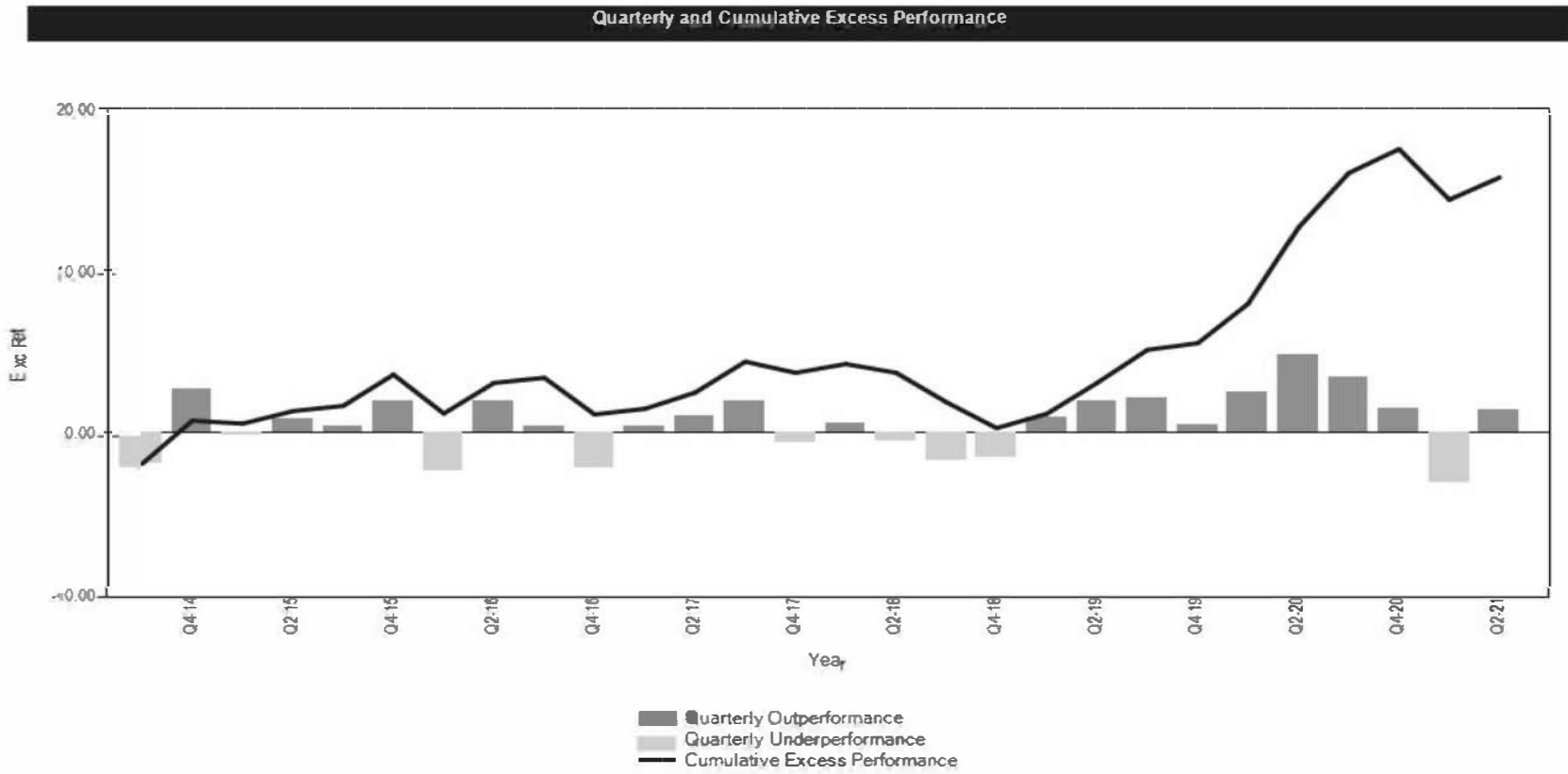


Exhibit 3: Cumulative Excess Performance Net of Fees



CONTRACT EXTENSION
AXIOM INVESTORS, LLC
ACTIVE NON-U.S. EMERGING MARKETS GROWTH EQUITIES
PORTFOLIO MANAGEMENT

PROPOSED RESOLUTION

WHEREAS, LACERS' current one-year contract extension with Axiom Investors, LLC (Axiom) for active non-U.S. emerging markets growth equities portfolio management expires on December 31, 2021; and,

WHEREAS, Axiom is currently "On Watch" for a benchmark change and organizational changes pursuant to the LACERS Manager Monitoring Policy; and,

WHEREAS, a one-year contract extension will provide the necessary time to evaluate Axiom's performance with its stated growth strategy relative to its benchmark as well as evaluate the organizational structure of the firm; and,

WHEREAS, on October 26, 2021, the Board approved the Investment Committee's recommendation to approve a one-year contract extension.

NOW, THEREFORE, BE IT RESOLVED, that the General Manager is hereby authorized to approve and execute a contract subject to satisfactory business and legal terms and consistent with the following services and terms:

<u>Company Name:</u>	Axiom Investors, LLC
<u>Service Provided:</u>	Active Non-U.S. Emerging Markets Growth Equities Portfolio Management
<u>Effective Dates:</u>	January 1, 2022 through December 31, 2022
<u>Duration:</u>	One year
<u>Benchmark:</u>	MSCI Emerging Markets Index
<u>Allocation as of September 30, 2021:</u>	\$401 million

October 26, 2021



To: Los Angeles City Employees' Retirement System Investment Committee

From: NEPC, LLC

Date: November 8, 2022

Subject: Axiom Investors - Contract Extension

Recommendation

NEPC recommends Los Angeles City Employees' Retirement System ('LACERS') extend their contract with Axiom for a period of one year from the date of contract expiry.

Background

Axiom was hired on April 11, 2014 to provide the Plan with public equity exposure to emerging markets. The portfolio's strategy is benchmarked against the MSCI Emerging Markets Index and has a performance inception date of May 1, 2014. As of September 30, 2022, Axiom managed \$255.6 million, or 1.3% of Plan assets in a separately managed account. The performance objective is to outperform the benchmark, net of fees, annualized over a full market cycle (normally three-to-five years). In October of 2021, Axiom's "Watch" status was extended due to the retirement of their President, Kurt Polk. Prior to this change, the lead portfolio manager on the account left the firm for medical reasons in 2020 and was replaced by the Chief Investment Officer, Andrew Jacobson. Mr. Jacobson was the original architect of the strategy. Additionally, in July of 2020, the benchmark was changed from the MSCI Emerging Markets Growth Index to the broader MSCI Emerging Markets index. The benchmark change request was granted given the growing level of concentration in the growth index. The top ten names made up 45% of the index in April of 2020. The change in the benchmark has not resulted in a change to the portfolio's style or investment strategy.

Mr. Polk was not a member of the investment team or involved with the day-to-day management of client portfolios. His duties have been spread across the members of the firm's Executive Committee. Additional support personnel have also been hired to further support the distinct departments that now handle Mr. Polk's previous responsibilities. Mr. Polk was also not a member of the investment team involved with the day-to-day management of LACERS' portfolio. We are comfortable with how the firm is faring post Mr. Polk's retirement.

With the rotation from growth stocks to value stocks that started at the end of 2021, the portfolio's performance has trailed the broad emerging market benchmark. Given the growth nature of the portfolio, in this market environment we expect that the Axiom portfolio will trail the benchmark. The portfolio's recent performance trails the benchmark and peers.

The current structure of LACERS' total emerging market equity exposure includes an anchor index portfolio, coupled with two style-specific active portfolios including Axiom (growth) and DFA (value). Further, the emerging markets allocation is augmented with an active small cap portfolio with a growth orientation. We note that most active managers have the ability to outperform the MSCI

Emerging Markets index over longer periods of time and we are supportive of maintaining the current structure.

Firm Overview

Axiom is an independent, employee-owned investment management firm with 24 equity partners and it was founded in 1998 by Andrew Jacobson. As of September 30, 2022 the firm had \$15.4 billion in assets under management. Prior to forming Axiom, the investment team was responsible for developing and managing the international equity strategy at Columbus Circle Investors, a division of PIMCO Advisors LP. The Axiom Emerging Markets team is currently co-led by Andrew Jacobson with three co-Portfolio Managers. Don Elefson and Jose Gerardo Morales have been on the team overseeing the strategy since 2012 and 2017 respectively. Young Kim joined the emerging markets team as co-Portfolio manager in the first quarter of 2021. The portfolio managers split the research coverage by geographic region and they leverage a shared research platform across all of Axiom's non-U.S. equity products.

The Axiom investment philosophy is to invest in quality companies that are growing and evolving better and more rapidly than expected. Critical to the investment process is the ability to identify these changes in growth, prior to them being reflected in expectations or market valuations. Axiom employs a bottom-up, growth-oriented investment discipline that relies on detailed fundamental stock analysis to identify companies that are improving more quickly than generally expected. The primary emphasis is to isolate those companies that are likely to exceed expectations, which they do by identifying and monitoring the key business drivers of each stock. They believe key business drivers are the leading indicators of stock price performance. Key drivers can include company specific, industry, macroeconomic and political factors. For each of these drivers, they survey a wide variety of sources to determine investor expectations.

The universe is defined as securities that have a minimum market cap of \$1.0 billion, are covered by 1 or more brokerage analysts and have liquidity of over \$5 MM/day. About 80% of Axiom's new ideas are typically identified as a consequence of specific, positive, fundamental developments in a company's operations (e.g., favorable sales of a new product, a significant restructuring initiative or a change in industry conditions). Axiom also screens the investment universe on a variety of financial and technical factors to help identify new ideas for further detailed fundamental analysis. These factors include positive earnings growth, positive earnings estimate revisions, positive price movement and favorable valuation characteristics.

Performance

Referring to Exhibit 1, as of September 30, 2022, since the portfolio's inception date of May 1, 2014, the portfolio has outperformed its benchmark by 0.4% and has ranked in the 51st percentile in its peer group. Over the past year, ended September 30, 2022, the portfolio has underperformed the benchmark by -8.1% and ranked in the 94th percentile in its peer group. Since inception, ended September 30, 2022, the information ratio was 0.13 and active risk, as measured by tracking error was 3.9%.

Referring to Exhibit 2, since inception, the cumulative effect of the strong underperformance over last five quarters performance has resulted in Axiom's portfolio underperforming in the trailing one, three and five years. Underperformance in the portfolio began with the rotation from growth to value toward the last half of 2021 and more recently portfolio underperformance was driven by



security selection with the portfolio experiencing adverse effects from the supply shock caused by the war in Europe.

Fees

The portfolio has an asset-based fee of 0.60% annually. This fee ranks in the 22nd percentile among its peers in the eVestment All Emerging Markets Equity Universe. In other words, 78% of the products included in the peer universe have a higher fee than the LACERS account.

Conclusion

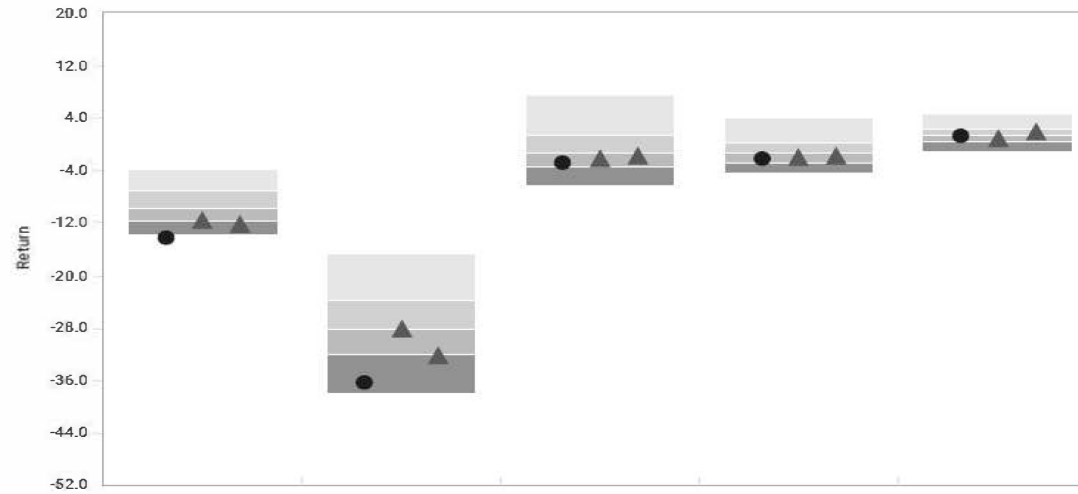
Axiom has experienced turnover in senior-level management and investment decision making roles and we believe the firm has demonstrated their ability to continue to manage the firm and LACERS portfolio. The portfolio has outperformed the MSCI Emerging Markets Index since inception, however, over most trailing time-periods evaluated the portfolio has underperformed due to weak performance over the last five quarters. NEPC continues to be a believer in the long-term efficacy of this strategy that focuses on understanding business fundamentals of companies that are growing faster than markets anticipate. Axiom has been removed from “Watch” status.

The following tables provide specific performance information, net of fees referenced above.



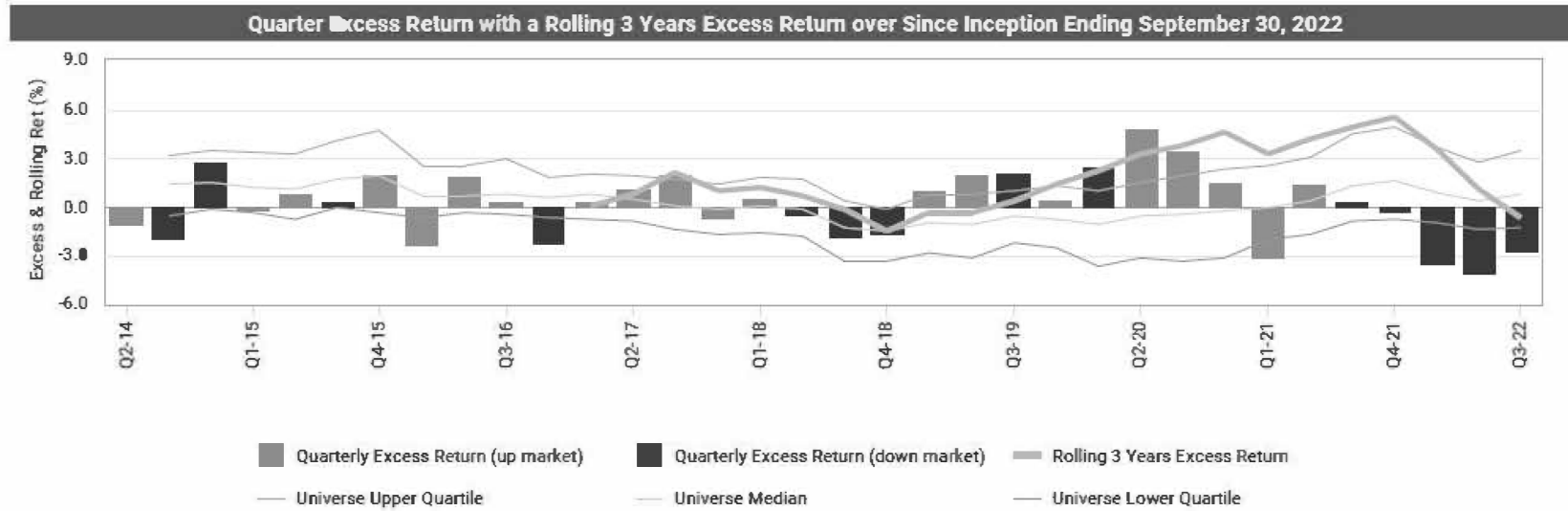


Exhibit 1: Universe Comparison Net of Fees Ending September 30, 2022



	3 Mo (%)	1 Yr (%)	3 Yrs (%)	5 Yrs (%)	Inception (%)
● Axiom Emerging Markets	-14.3 (98)	-36.2 (94)	-2.7 (70)	-2.1 (64)	1.3 (51)
▲ MSCI Emerging Markets (Net)	-11.6 (73)	-28.1 (51)	-2.1 (62)	-1.8 (61)	0.9 (65)
▲ MSCI Emerging Markets Growth (Net)	-12.1 (81)	-32.1 (76)	-1.7 (59)	-1.6 (57)	2.1 (31)
5th Percentile	-3.7	-16.7	7.5	4.1	4.7
1st Quartile	-7.0	-23.7	1.5	0.4	2.4
Median	-9.8	-28.1	-1.2	-1.3	1.4
3rd Quartile	-11.8	-32.0	-3.3	-2.6	0.6
95th Percentile	-13.7	-37.8	-6.2	-4.3	-1.1
Population	319	314	286	252	196

Exhibit 2: Cumulative Excess Performance Net of Fees Ending September 30, 2022



CONTRACT EXTENSION
AXIOM INVESTORS, LLC
ACTIVE NON-U.S. EMERGING MARKETS GROWTH EQUITIES
PORTFOLIO MANAGEMENT

PROPOSED RESOLUTION

WHEREAS, LACERS' current one-year contract extension with Axiom Investors, LLC (Axiom) for active non-U.S. emerging markets growth equities portfolio management expires on December 31, 2022; and,

WHEREAS, a one-year contract extension will provide the necessary time to evaluate Axiom's performance with its stated growth strategy relative to its benchmark; and,

WHEREAS, on November 22, 2022, the Board approved the Investment Committee's recommendation to approve a one-year contract extension.

NOW, THEREFORE, BE IT RESOLVED, that the General Manager is hereby authorized to approve and execute a contract subject to satisfactory business and legal terms and consistent with the following services and terms:

<u>Company Name:</u>	Axiom Investors, LLC
<u>Service Provided:</u>	Active Non-U.S. Emerging Markets Growth Equities Portfolio Management
<u>Effective Dates:</u>	January 1, 2023 through December 31, 2023
<u>Duration:</u>	One year
<u>Benchmark:</u>	MSCI Emerging Markets Index
<u>Allocation as of September 30, 2022:</u>	\$256 million

November 22, 2022



REPORT TO BOARD OF ADMINISTRATION

From: Investment Committee
Elizabeth Lee, Chair
Janna Sidley
Nilza R. Serrano

MEETING: NOVEMBER 22, 2022
ITEM: VIII - D

SUBJECT: PRESENTATION BY AKSIA CA LLC OF THE PRIVATE EQUITY PROGRAM 2023 STRATEGIC PLAN AND POSSIBLE BOARD ACTION

ACTION: CLOSED: CONSENT: RECEIVE & FILE:

Recommendation

That the Board adopt the Private Equity Program 2023 Strategic Plan.

Discussion

On November 8, 2022, the Committee considered the attached report regarding the Private Equity Program 2023 Strategic Plan. The Committee heard a presentation from Jeffrey Goldberger and Trevor Jackson of Aksia CA LLC (Aksia), LACERS' Private Equity Consultant. The plan, developed by Aksia with input from staff, establishes strategic objectives and investment plan recommendations for the next calendar year. Aksia will be present at the Board meeting of November 22, 2022, should the Board desire to hear a presentation of the proposed plan.

Strategic Plan Impact Statement

The annual private equity strategic plan assists the Board in building a diversified private equity and total fund portfolio and aligns with the Strategic Plan Goals of optimizing long-term risk adjusted investment returns (Goal IV) and promoting good governance practices (Goal V).

Prepared By: Wilkin Ly, Investment Officer III, Investment Division

NMG/RJ/BF/WL:rm

Attachment: 1. Report to Investment Committee Dated November 8, 2022



LACERS
LA CITY EMPLOYEES'
RETIREMENT SYSTEM



REPORT TO INVESTMENT COMMITTEE
From: Neil M. Guglielmo, General Manager

MEETING: NOVEMBER 8, 2022
ITEM: IV

SUBJECT: PRESENTATION BY AKSIA CA LLC OF THE PRIVATE EQUITY PROGRAM 2023 STRATEGIC PLAN AND POSSIBLE COMMITTEE ACTION

ACTION: CLOSED: CONSENT: RECEIVE & FILE:

Recommendation

That the Committee recommend to the Board the adoption of the Private Equity Program 2023 Strategic Plan.

Discussion

Aksia CA LLC (Aksia), LACERS' Private Equity Consultant, with input from staff, has developed the proposed Private Equity Program 2023 Strategic Plan, which considers strategic objectives and investment plan recommendations for calendar year 2023. Staff has reviewed the plan and recommends its adoption. Aksia will present the proposed plan.

Strategic Plan Impact Statement

The annual private equity strategic plan assists the Board in building a diversified private equity and total fund portfolio and aligns with the Strategic Plan Goals of optimizing long-term risk adjusted investment returns (Goal IV) and promoting good governance practices (Goal V).

Prepared by: Wilkin Ly, Investment Officer III, Investment Division

NMG/RJ/BF/WL:rm

Attachment: 1. LACERS Private Equity Program 2023 Strategic Plan – Aksia CA LLC

Aksia LLC

LACERS Private Equity Program 2023 Strategic Plan

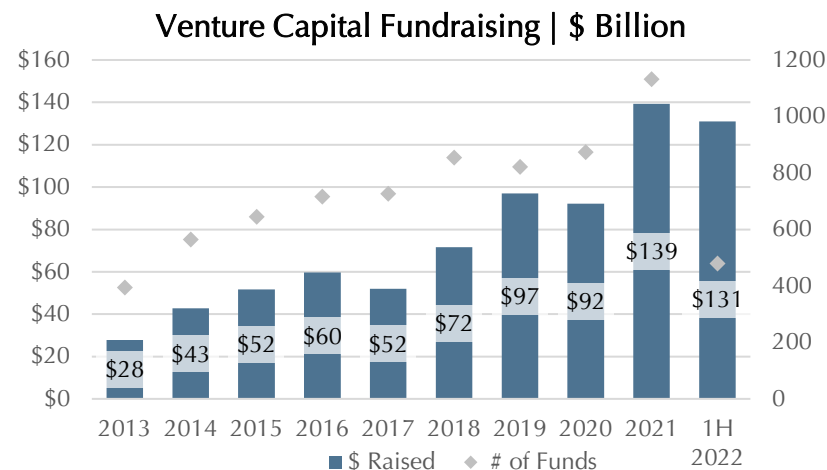
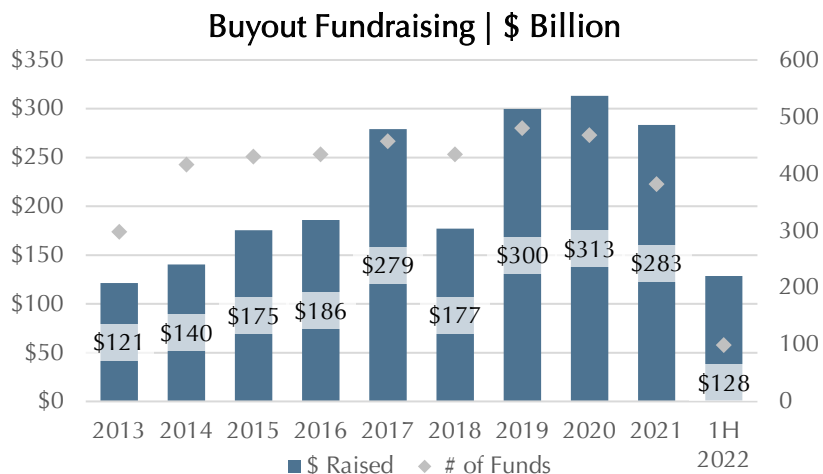


www.aksia.com

Table of Contents

• Private Equity Market Overview	3
• 2022 Strategic Plan Refresher	10
• 2023 Pacing Analysis	15
• LACERS Portfolio Exposures	17
• 2023 Strategic Plan Recommendations	24

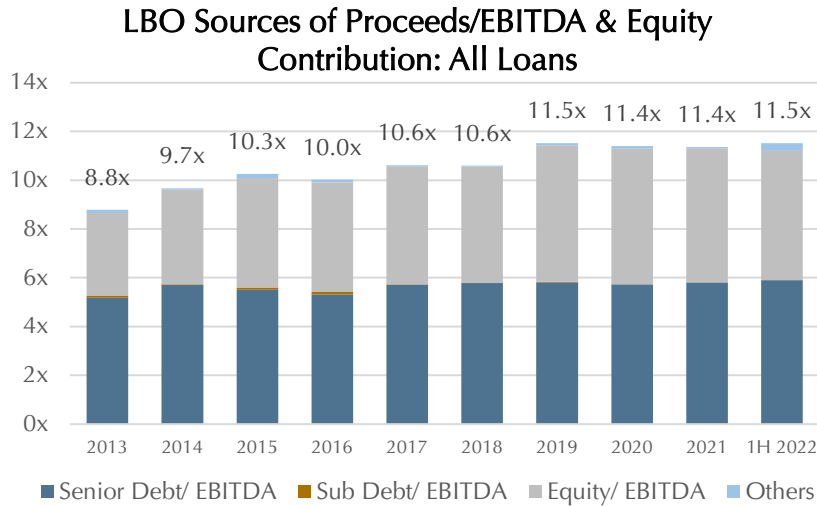
Fundraising Activity – North America



- The buyout fundraising landscape remains crowded, with many PE firms back in market following accelerated deployment in 2021. However, some LPs are facing tightening allocations given the denominator effect which is leading to more drawn-out fundraising cycles and may result in some PE firms having difficulty raising their target amounts

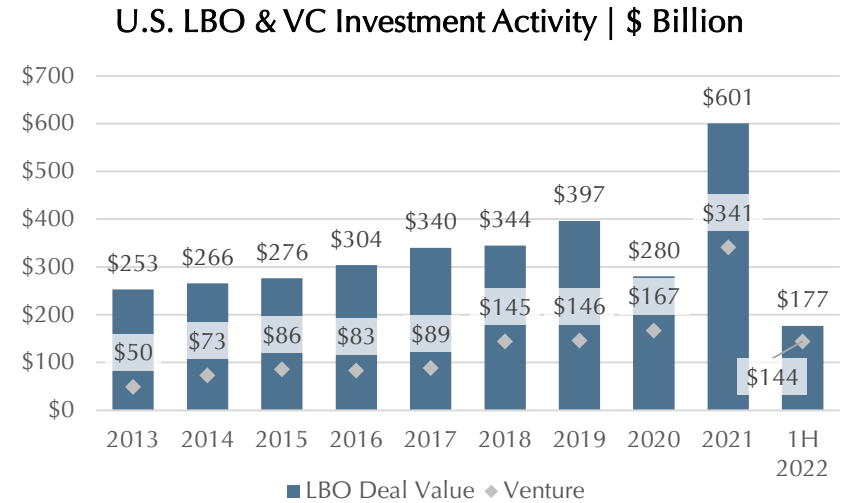
- Fundraising in 2022 jumped out of the gate strongly as momentum from last year spilled over, but we believe it is likely to slow down as investors already have their allocations for the year almost filled (if not already filled) and there is concern for the denominator effect as public equity valuations continued to decline

Investment Activity – North America



Source: Leveraged Commentary & Data (LCD), Pitchbook as of June 2022

- Buyout valuation multiples remain elevated but may begin to compress given the pullback in public markets and rising interest rates

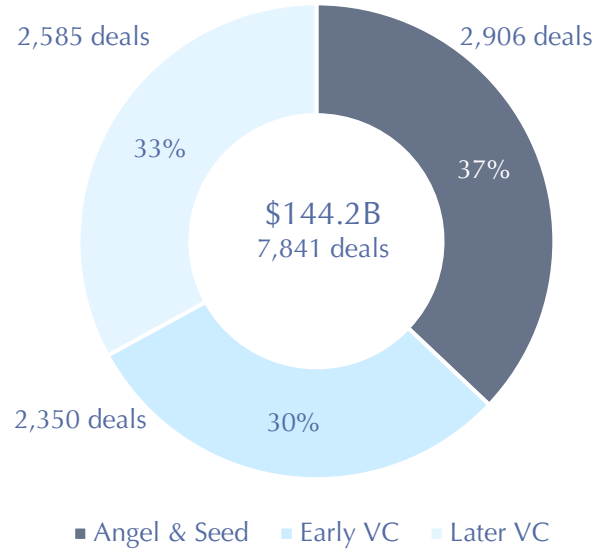


Source: Pitchbook & National Venture Capital Association, as of June 2022

- We saw a slowdown in deal value across both buyouts and venture capital during the first half of 2022. Looking forward, several PE managers have indicated the possibility of increased take private activity, while within the venture capital landscape, many founders are avoiding fundraising at a down round

Investment Activity – U.S.

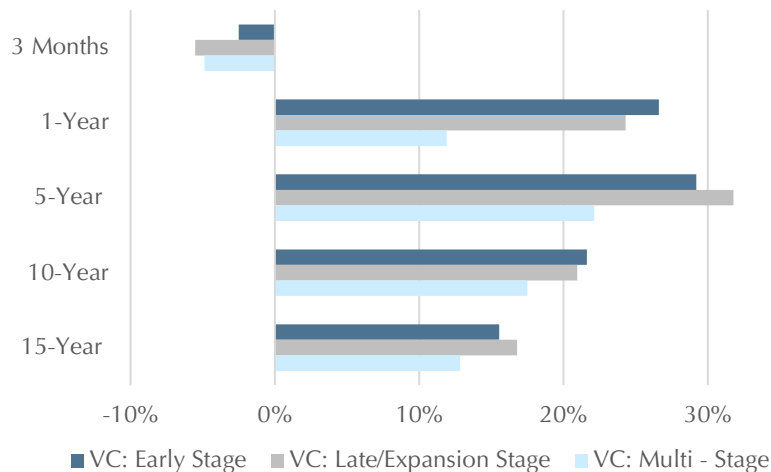
U.S. 1H 2022 Venture Investment by Stage



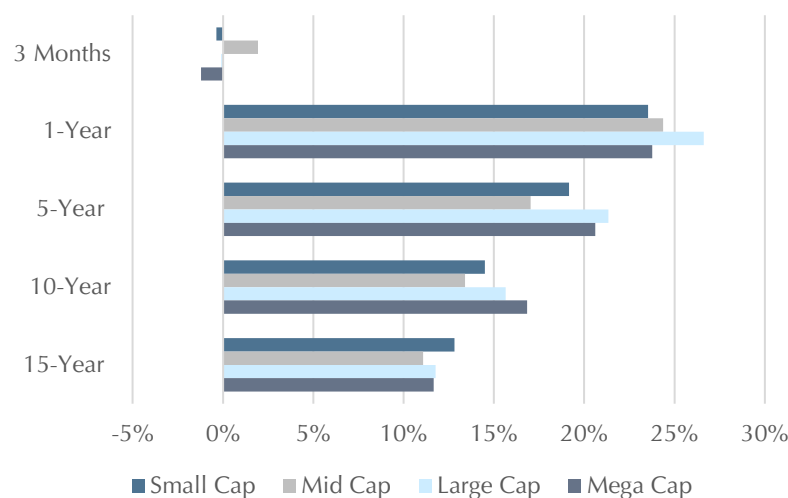
- There has been a slowdown in venture investment activity as of 1H 2022. However, the breakdown of deals has not meaningfully changed

Market Performance

Venture Capital Returns



Buyout Returns



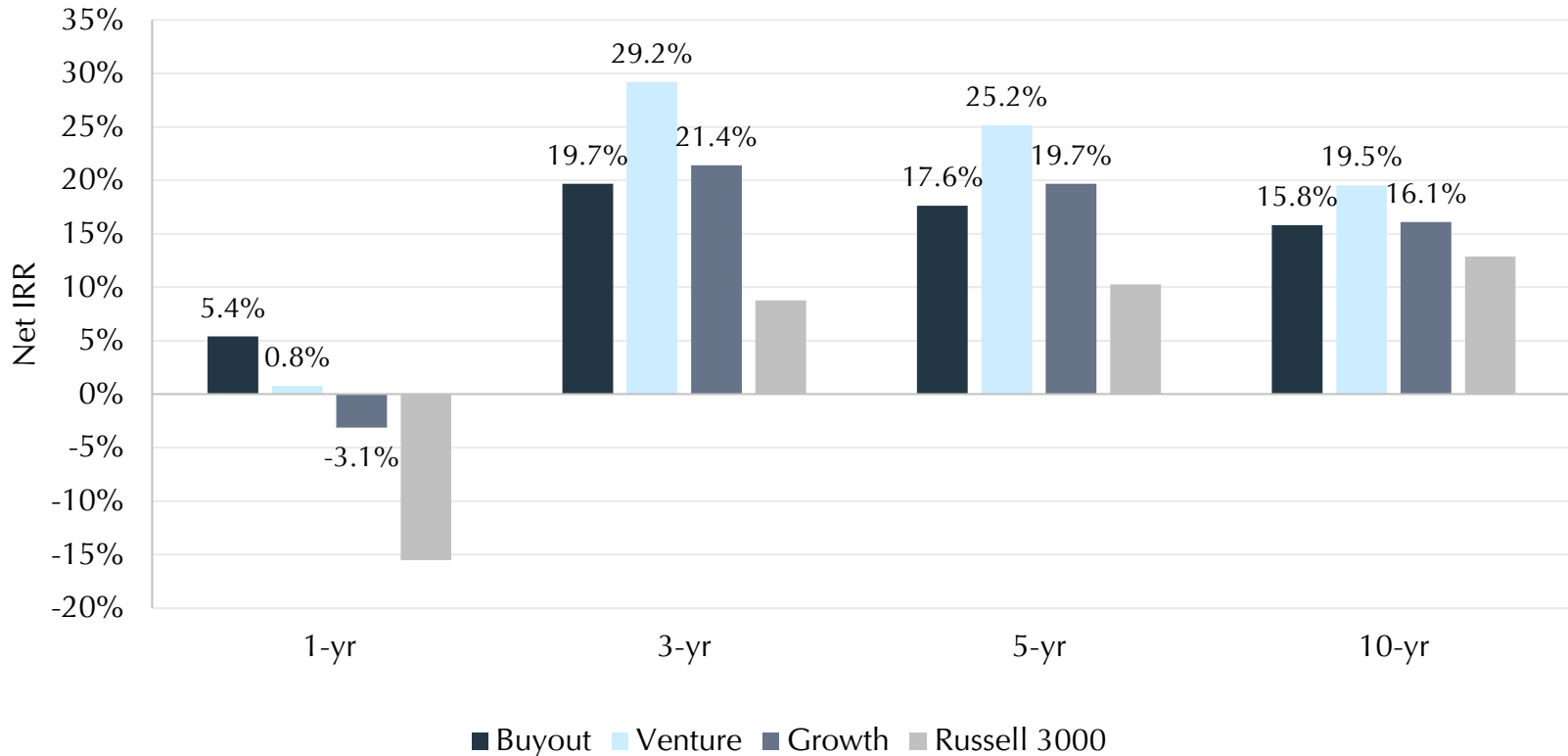
- We expect the significant compression in the public markets to start reverberating through Venture returns in 2022 with some lag due to stage blend and valuation policies

- Performance of most buyout strategies contracted slightly in Q1 2022, which was not unexpected given declines in public markets. Despite the decline, buyout funds have posted 20%+ returns over the past 12 months

Private Equity Industry Returns Relative to Public Markets

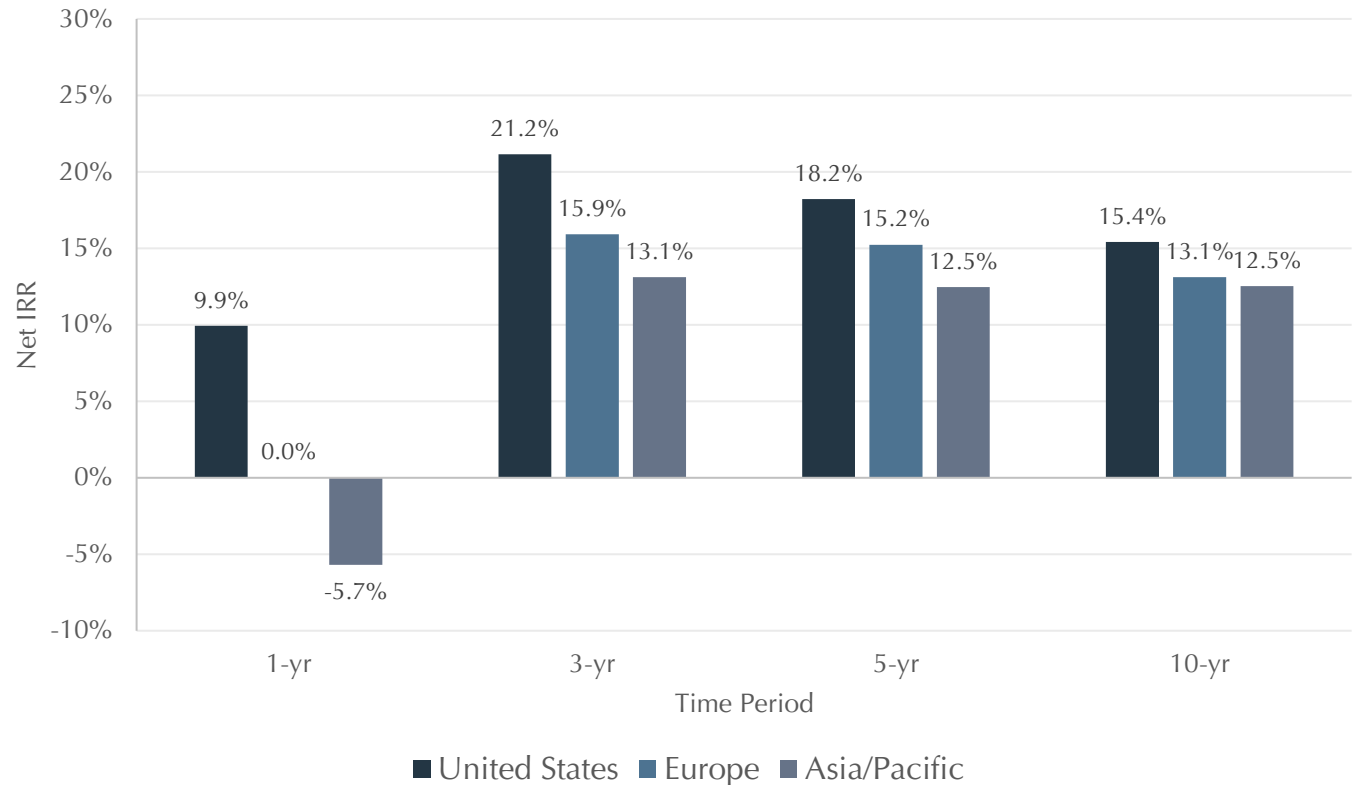
- Venture and growth equity have outperformed buyouts and public equity in most time periods, excluding the past year
- All private equity strategies outperformed the Russell 3000 over all time horizons

Time Horizon Returns (as of June 30, 2022)



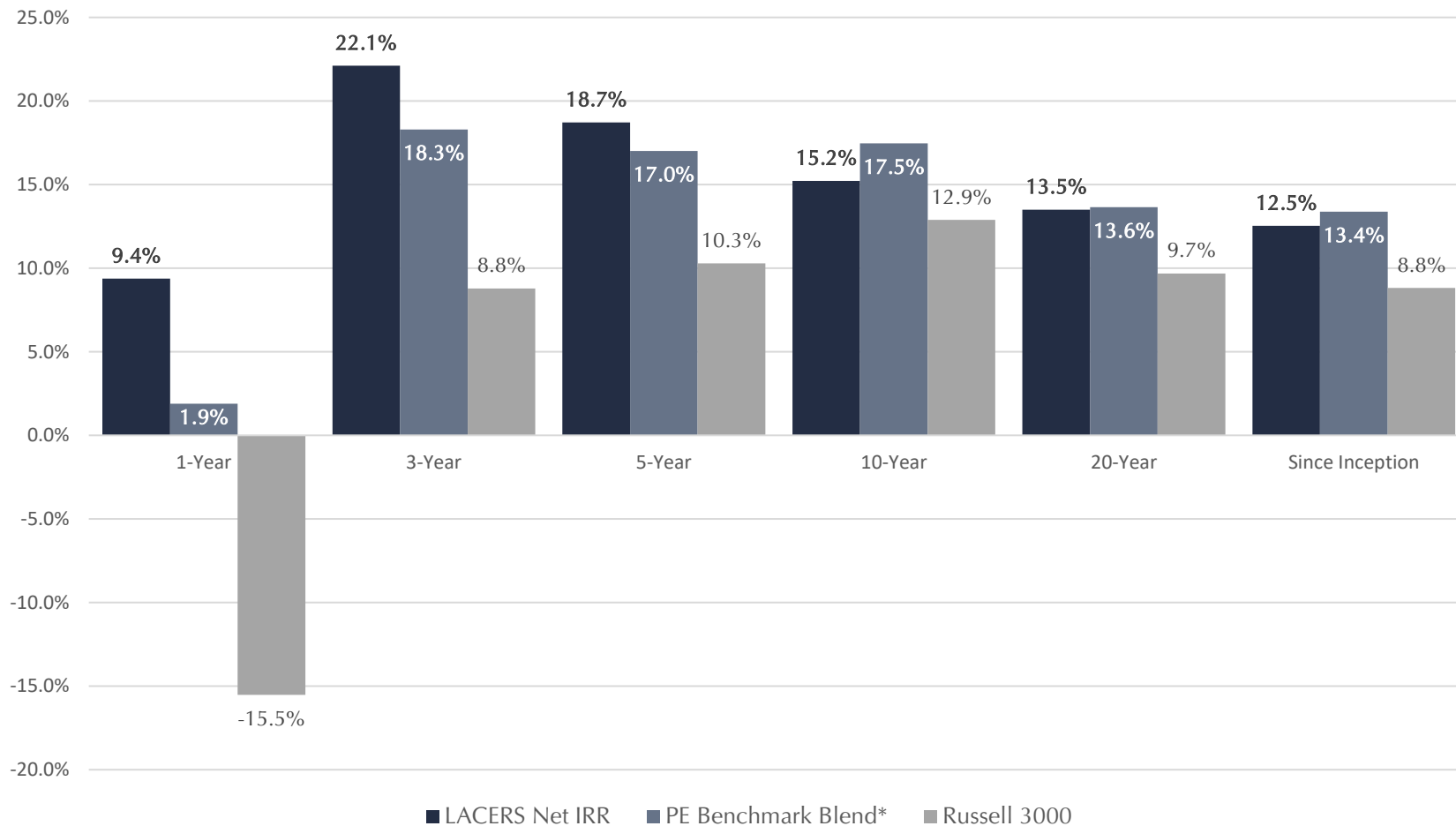
- U.S. Private Equity outperformed both Europe and Asia/Pacific private equity across all time periods as of June 30, 2022
- While risk varies by specific geography, broadly speaking, Europe and Asia/Pacific appear to offer commensurate returns with the U.S. when looking at longer-term returns (i.e. 10-year)
- Adding international exposure can improve diversity in LACERS' PE portfolio without sacrificing risk adjusted returns

Horizon Returns By Geography (As of June 30, 2022)



Source: Cambridge Associates.

Horizon Returns as of June 30, 2022



* PE Benchmark Blend includes the Russell 3000 Index + 400bps (inception – January 31, 2012), the Russell 3000 Index + 300bps (February 1, 2012 – December 31, 2021), and the Cambridge Associates Global PE and VC Index beginning January 1, 2022.

2022 Strategic Plan - Refresher

- Initial Pacing Recommendations*
 - Commitment plan of \$1.375 billion proposed for 2022
 - Commitments in 18-25 firms with a target size of \$50-\$100 million per commitment / relationship
 - Includes 5-7 investments of at least 10% of commitments to various Emerging Managers
- Long-Term Investment Recommendations
 - Develop a framework for the implementation of a co-investment program – from both from an investment and policy perspective
 - Develop a framework for a potential secondary sale – from both from an investment and policy perspective
- Tactical Investment Recommendations
 - Selectively add exposure internationally – primarily to Europe and Asia
 - Increase exposure to Buyouts relative to other sub-asset classes and decrease Venture Capital exposure
 - Consolidate commitments with top performing managers
 - Continue to manage underlying sector exposures
 - Add exposure to strategies designed to outperform in down markets – i.e. Value-Oriented Managers, Turnaround Managers, Distressed Managers

*Updated in 2022 to account for changes in total plan assets due to market environment.

Commitment Statistics

- 2022 Summary Statistics

- \$787 million in total commitments through September 30, 2022
- Annual target is \$1.375 billion per 2022 Strategic Plan
- Actual working target is \$1B - \$1.1B, reduced due to market volatility

- Geographic Breakdown of ITD Commitments

- ~75% to North American-focused funds
- ~13% to European-focused funds
- ~9% to Globally-focused funds
- ~3% to Asia Pacific-focused funds

- Sector Breakdown of ITD Commitments

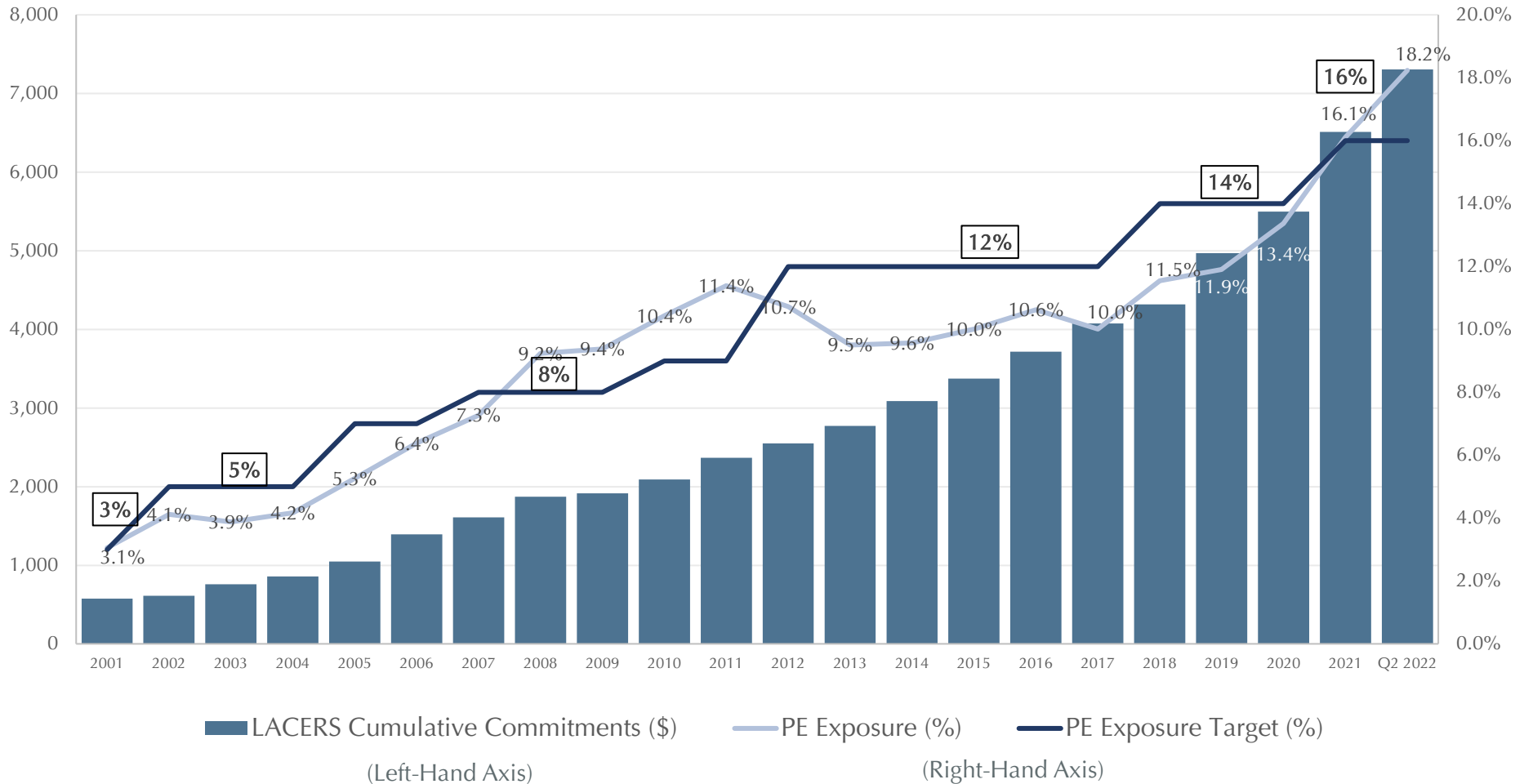
- 61% to Buyout funds
- 23% to Venture and Growth Equity funds
- 16% to Credit funds, Real Asset funds, Secondaries, and Fund of Funds

Aggregate Portfolio Summary As Of June 30, 2022

- As of June 30, 2022 the aggregate portfolio's fair market value of \$3.8 billion represents 18.2% of Total Plan Assets

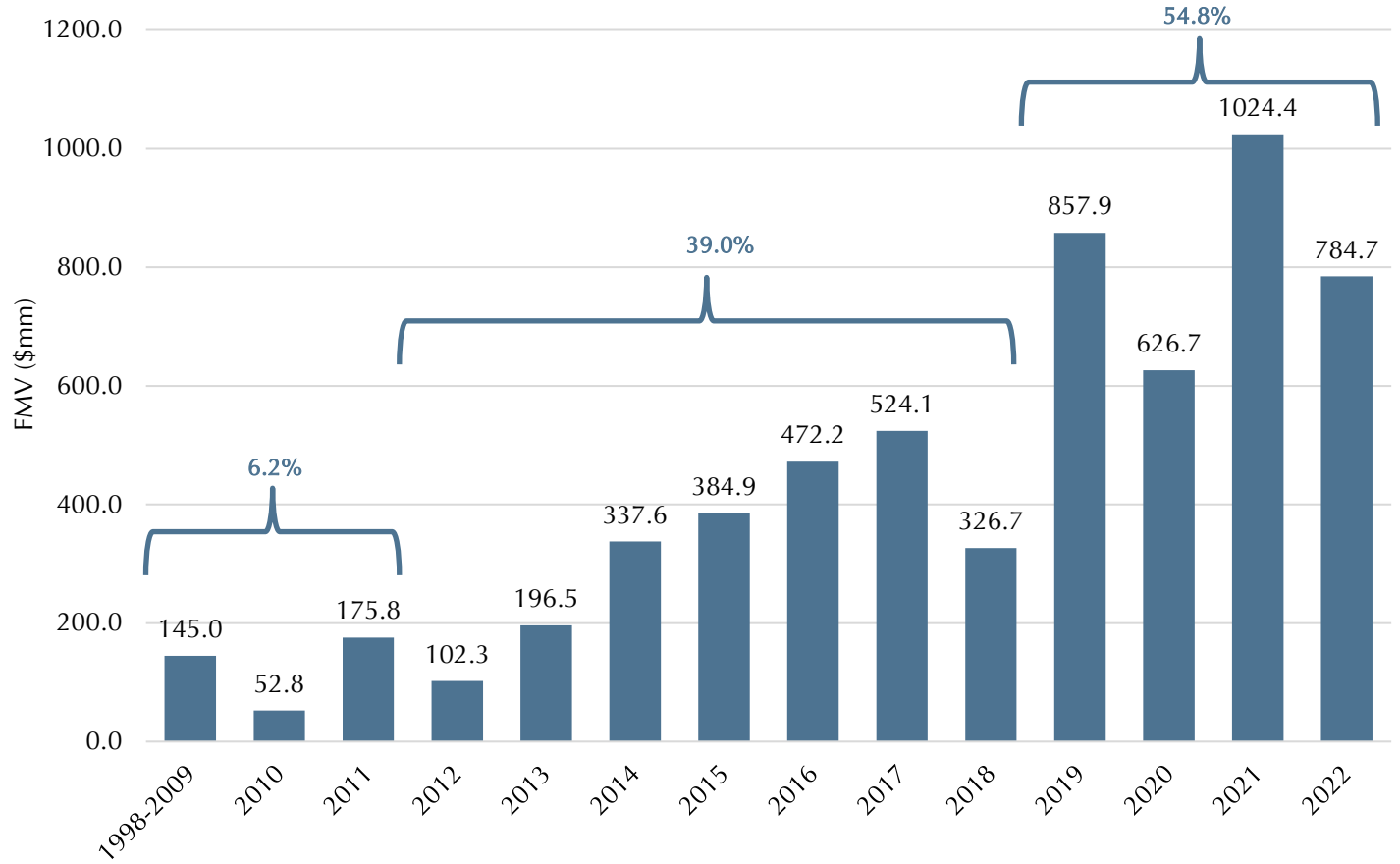
Aggregate Portfolio Private Equity Exposure Summary	
Total Plan Market Value	\$20.6bn
Private Equity Exposure Target (%)	16.0%
Private Equity Exposure Target (\$)	\$3.3bn
Private Equity Exposure (%)	18.2%
Fair Market Value ("FMV")	\$3.8bn

- Since inception (1995), LACERS has committed more than \$7.0 billion to private equity
- Target exposure to private equity is 16.0%



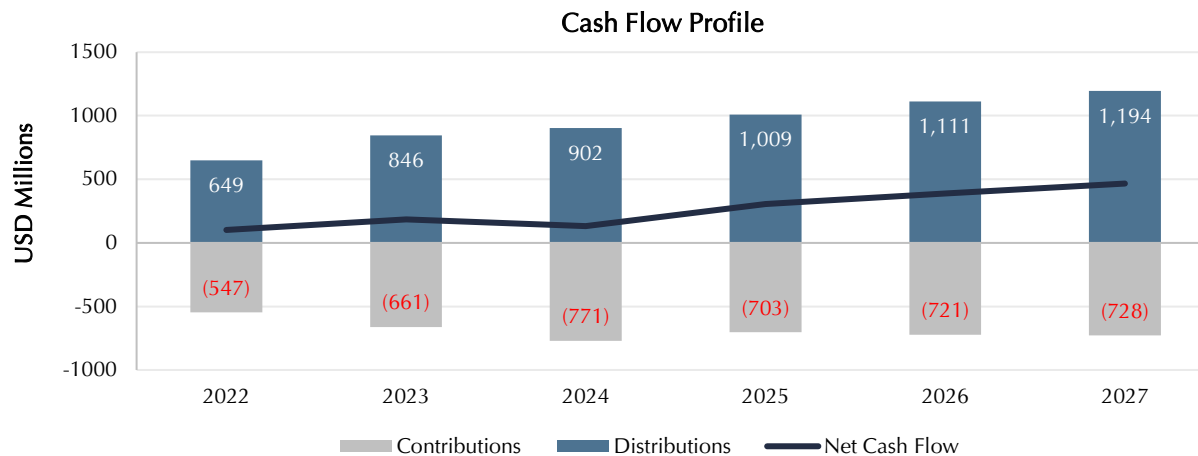
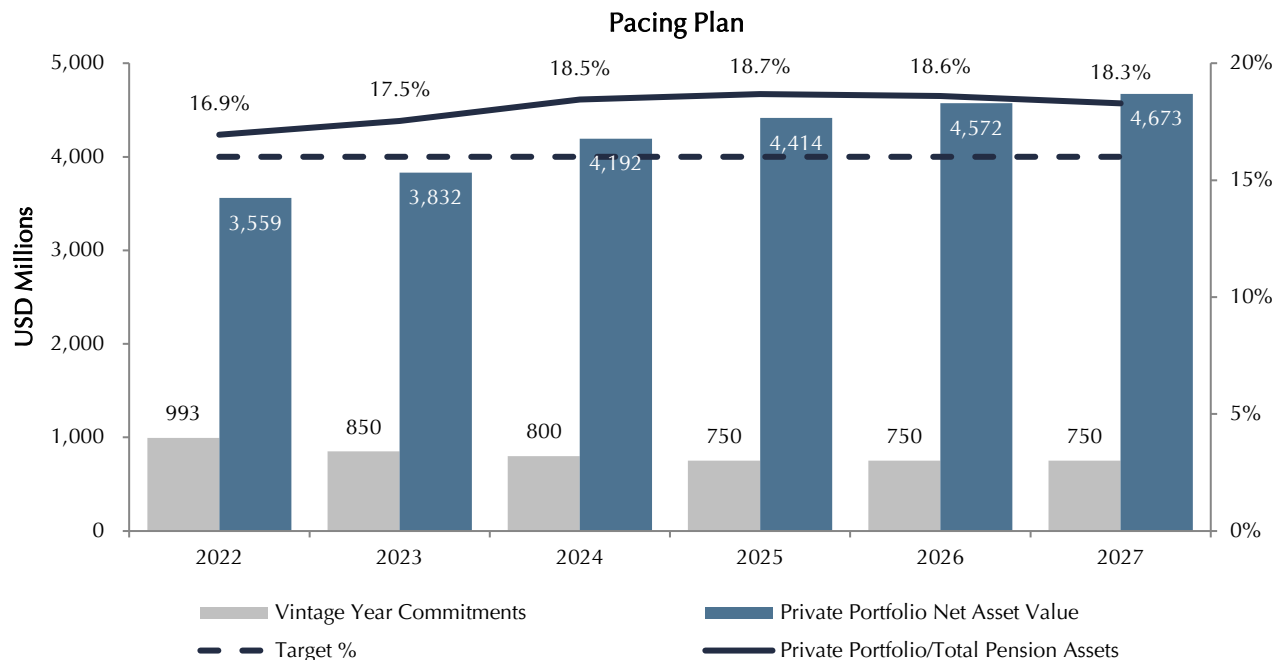
LACERS Private Equity Program - Fair Market Value By Vintage Year

- Legacy exposure (1998 – 2011) accounts for ~6.2% of LACERS total private equity exposure
- The bulk of LACERS current private equity exposure (54.8%) is from funds with vintage years from 2019 – 2022



Updated Pacing Model* – As of June 30, 2022

- The performance of public markets year to date has contributed to LACERS being overweight in PE
- Assumes 4% annual TPA growth
- Includes a \$150mm commitment to a co-investment SMA in 2023



*Analysis excludes private credit strategies.

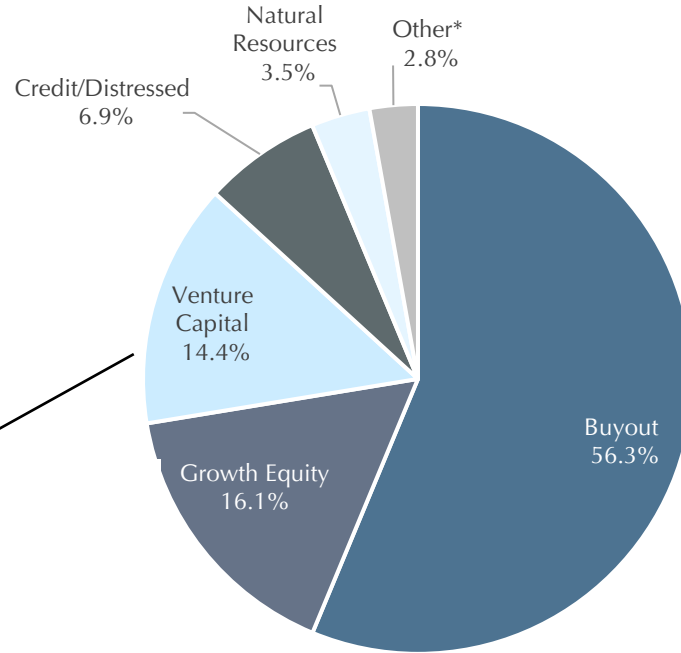
LACERS Private Equity Long-Term Targets

Private Equity Asset and Sub-Asset Classes	LACERS Exposure (%)	Aksia's Suggested Long-Term Target
Buyouts	56.3%	60% – 80%
Large Buyouts	24.9%	
Medium Buyouts	28.2%	
Small Buyouts	3.2%	
Venture Capital / Growth Equity	30.5%	20% – 40%
Venture Capital	14.4%	
Growth Equity	16.1%	
Credit / Distressed	6.9%	0% - 10%
Natural Resources / Other*	6.3%	0% – 10%

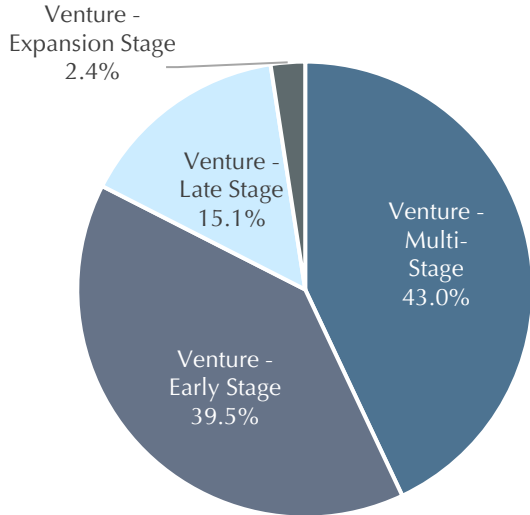
*Other includes Secondary funds and Fund of Funds.

LACERS Exposure / Commitments by Asset Class

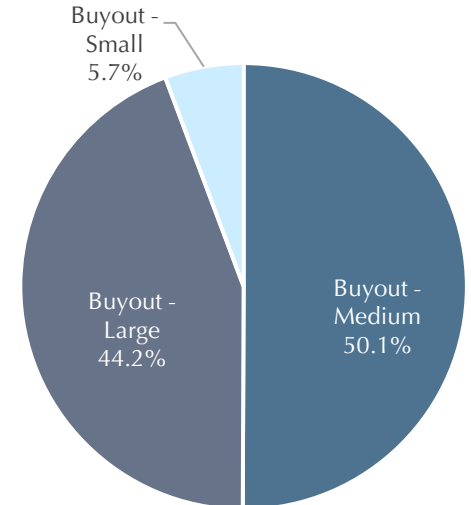
Current Exposure



Venture Exposure



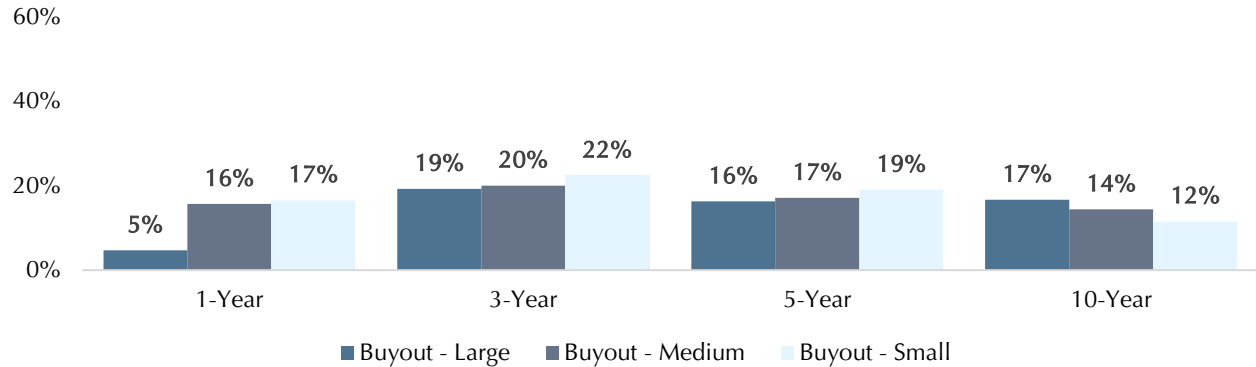
Buyout Exposure



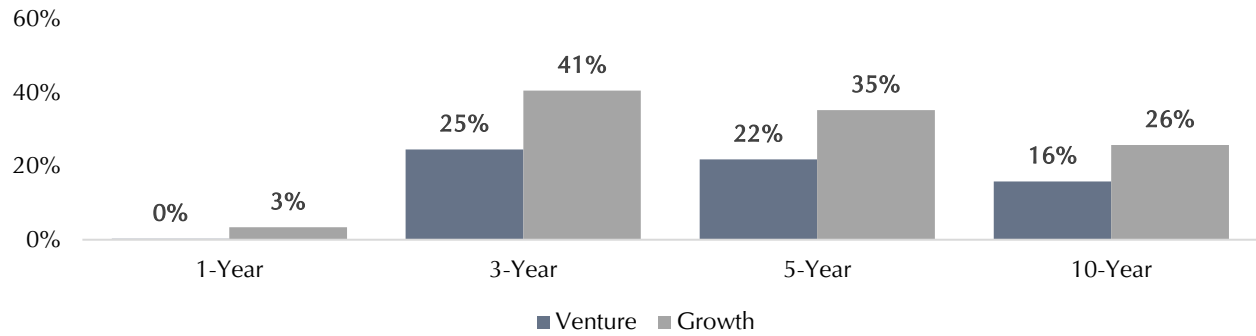
*Other includes Secondary funds and Fund of Funds.

LACERS Horizon Returns by Sub-Strategy

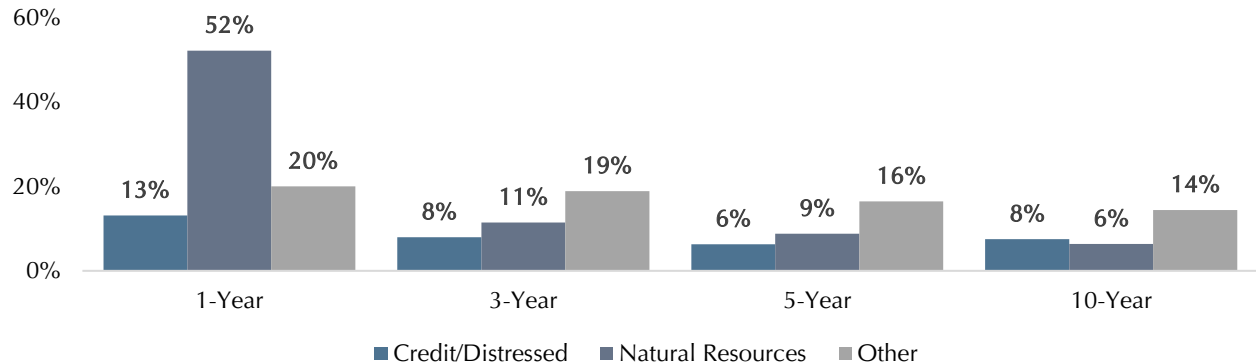
- LACERS' Large Buyout funds have outperformed Small and Medium Buyout funds over time



- LACERS' Growth Equity investments have outperformed Venture Capital over various time horizons

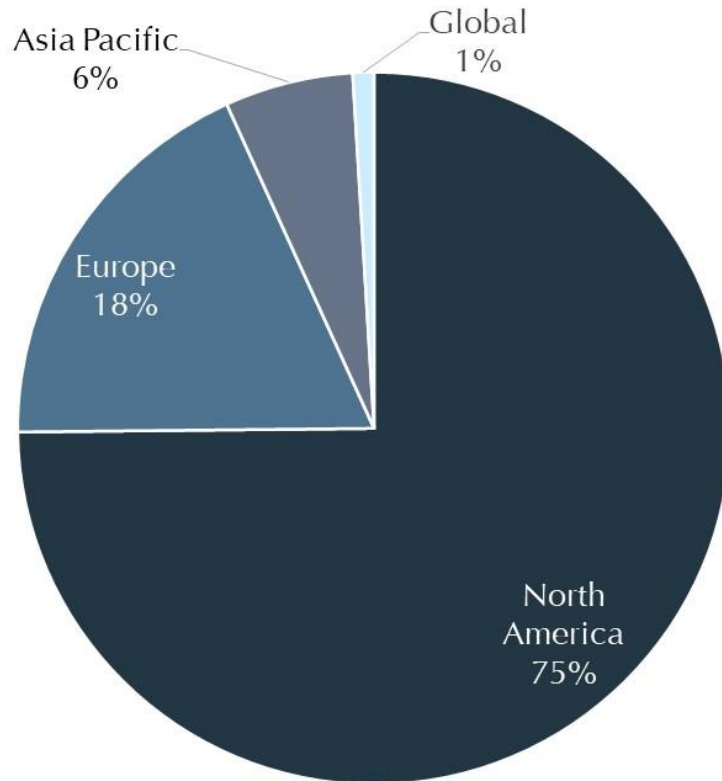


- LACERS' Credit funds have been challenged over the recent years

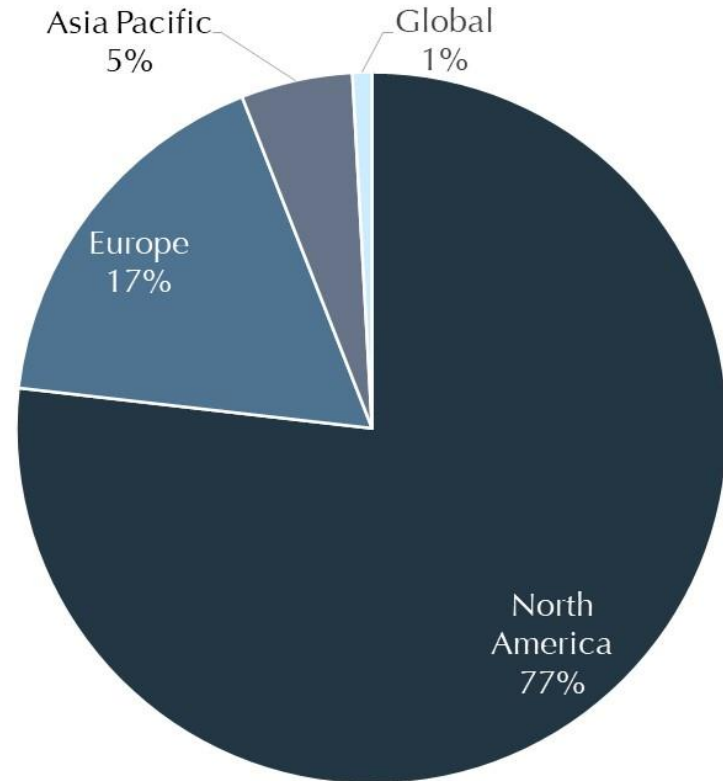


LACERS Commitments by Geography

Fund Commitments – By Geography

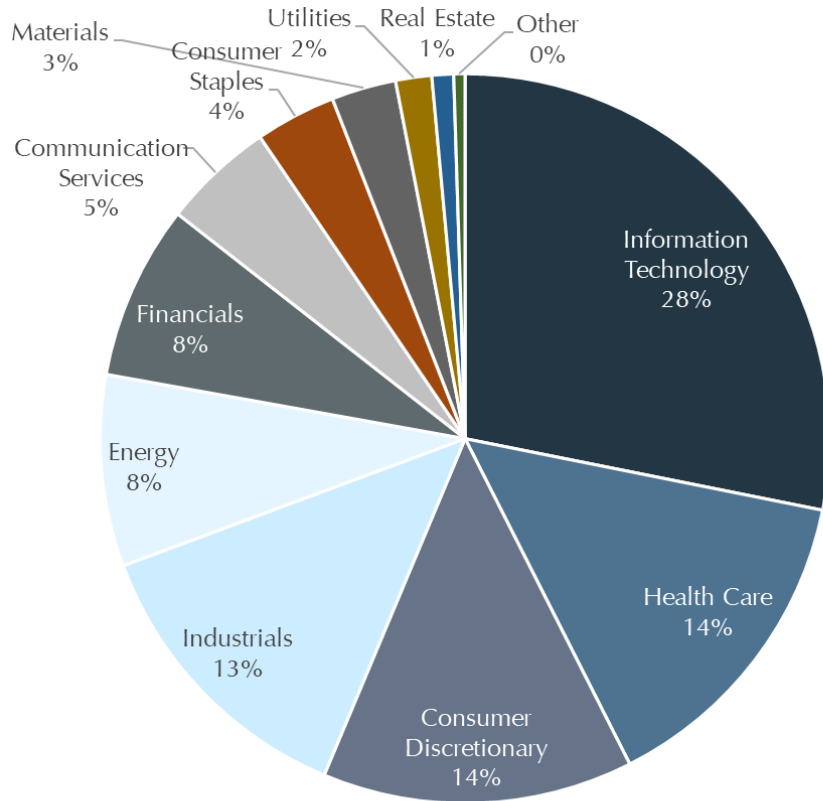


Current Exposure – By Geography

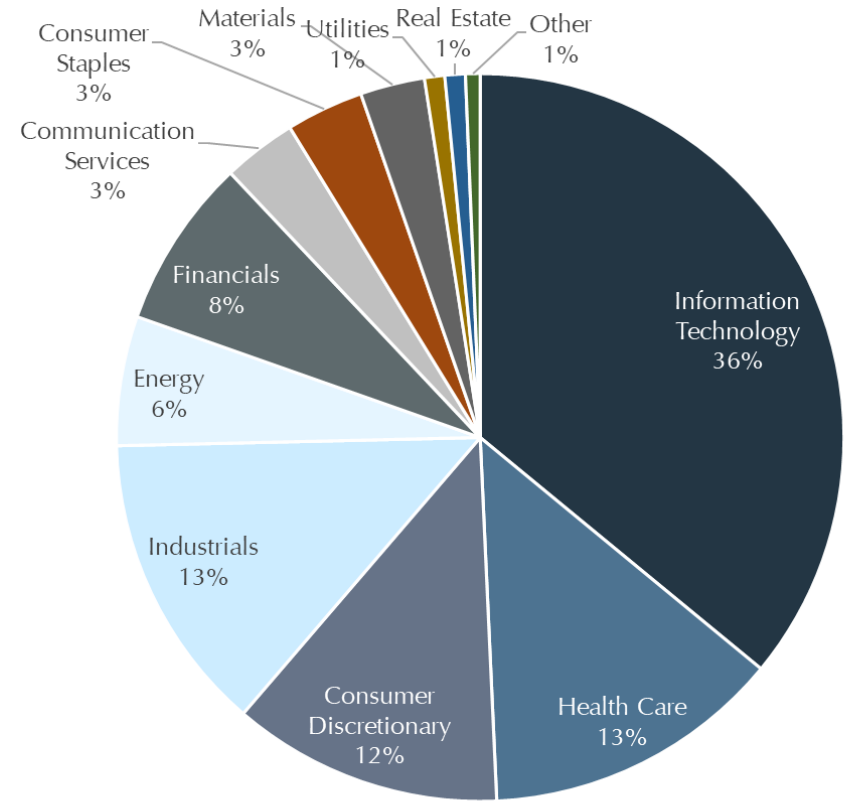


LACERS Commitments and Exposure by Sector

Fund Commitments – By Sector



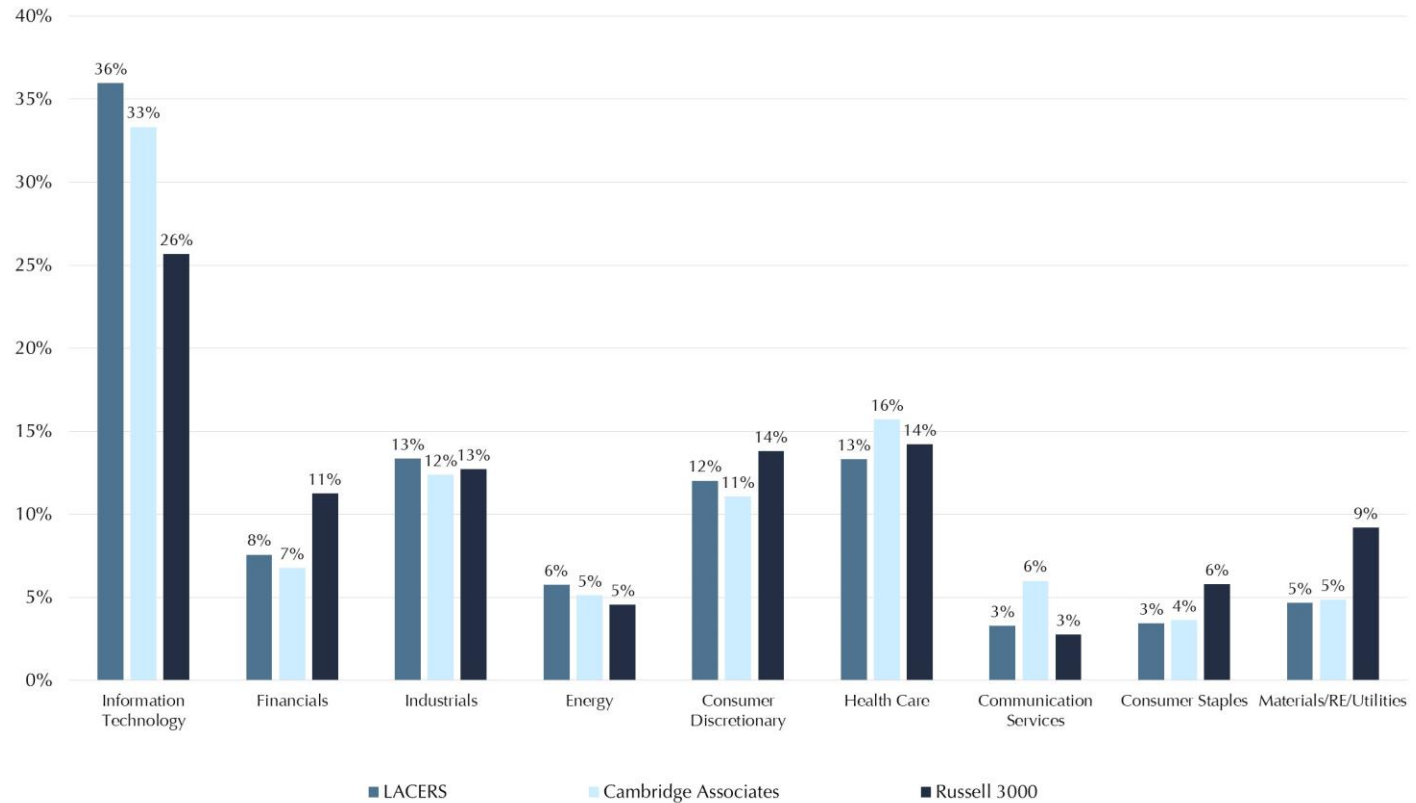
Current Exposure – By Sector



LACERS Exposure by Sector vs. Benchmarks

LACERS Sector Exposure vs. Benchmarks

- When compared to public and private benchmarks, LACERS is over-weight in the Information Technology sector
- When compared to private benchmarks, LACERS is under-weight in the Healthcare sector
- LACERS biggest mismatch with public markets is in the Information Technology sector



Source: Cambridge / Aksia TorreyCove research.

SWOT Analysis – Strengths & Weaknesses

Strengths

- Existing GP Relationships: LACERS currently maintains relationships with a number of high-quality GPs that should continue to scale over time
- Brand / Reputation: LACERS has a reputation in the market as a long-term investor with a sophisticated investment staff, which should open door to high-quality established and emerging firms
- Disciplined Investment Process: LACERS investment process allows for disciplined decision making and consistent deployment regardless of market dislocations
- Flexible Mandate: LACERS has the ability to invest selectively across a variety of sub-sectors within private equity
- Sector Exposure: LACERS PE portfolio is currently weighted towards IT (36%) and Healthcare (13%), both sectors which have proven to be resilient in downturns and should benefit going forward from secular market trends
- Liquidity: LACERS has considerable plan liquidity to maintain the current private equity commitment pacing

Weaknesses

- Over-Diversification: LACERS has an overdiversified private equity portfolio, with a large enough number of relationships that returns may exhibit reversion to the mean
- Legacy Performance: The legacy portfolio will continue to be a drag on performance, including the Specialized Portfolio
- Co-Investment Program: Today, LACERS does not have an active co-investment program. Developments on a program have been discussed and will potentially be implemented in 2023

SWOT Analysis – Opportunities & Threats

▪ Opportunities

- Portfolio Consolidation: LACERS has existing relationships with a number of high-quality GP's, and has the potential to develop long-term relationships with other high-quality GP's including emerging managers
- Co-Investments: Pursue a co-investment strategy that increases exposure to core GP's while simultaneously helping to mitigate costs
- Secondary Transactions: The secondary market has evolved as both an investment option as well as a portfolio management tool; Given recent market volatility and rising PE allocations, this part of the market could see accelerated LP interest
- Emerging Managers: Today's emerging managers may be the new generation of top-tier performers. The ability to invest in these managers early on in their life may help with long-term access to outperforming emerging managers
- Market Volatility: Consistent private equity commitment pacing during periods of market volatility has historically proven to deliver some of the best vintage year performance for private equity portfolios

▪ Threats

- Broad Co-Investment Appetite: Many LP's are seeking co-investments and are fostering relationships with GP's or third parties to secure access
- Market Volatility: Recent market economic and interest rate uncertainty have shrunk portfolio values, contracting commitment pacing as private equity becomes a larger share of overall portfolio and public market exits become more challenging
- Increased Input Pricing and Margin pressure: Rising inflation and interest rates have increased company borrowing costs, put pressure on company margins, and constricted company cash flows
- Disclosures / Regulations: AB2833 and other reporting requirements may be disagreeable to certain top-quartile GPs; a bigger issue in Venture Capital vs. Buyouts sub-sector

2023 Long-Term Strategic Plan Recommendations

- **Pacing**
 - Maintain relatively consistent longer-term pacing despite market volatility
 - Commitment plan of up to \$850 million proposed for 2023
 - Commitments to 10-15 firms with a target size of \$40-\$75 million per commitment
 - 3-5 investments to Emerging Managers representing at least 10% of total annual commitments

- **Broad Portfolio Considerations**
 - Continue consolidating commitments with top performing managers
 - Continue to selectively add exposure internationally – primarily to Europe, Asia, and Latin America
 - Continue increasing exposure to buyouts relative to other sub-asset classes
 - Continue to manage underlying sector exposures
 - Monitor IT exposure across buyout, growth, and venture
 - Continue to diversify sector exposure, including healthcare and other select cyclical and value-oriented sectors
 - Continue to add exposure to strategies designed to outperform in down, sideways, late cycle markets – i.e. value-oriented managers, turnaround managers, distressed managers

2023 Short-Term Tactical Recommendations

- **Lean Into the Strengths**
 - Existing GP Relationships: maintain exposure to existing, high conviction managers that are back in market in 2023 where possible; this would include the re-evaluation of the strategic and performance value of these relationships to the overall portfolio
 - Brand / Reputation: Leverage LACERS reputation to initiate new relationships of scale with high quality GPs that are in market in 2023 and where the relationship can be scaled over time; Given portfolio value and market volatility, it will be challenging to allocate to all key current relationship as well as add much new relationships
 - Flexible Mandate: Leverage LACERS ability to invest across sub-asset classes and take advantage of the full spectrum of private equity activities
 - Continue to develop a framework for the implementation of co-investment program with potential 2023 launch
 - Continue developing a framework for the implementation of a secondary program and/or secondary fund sales if Board and Staff believes it offers some benefit in the short-term
 - Leverage relationships with commingled secondary funds and secondary transaction vendors
 - Continue exploring potential secondary sales when conditions are favorable and possible valuation discounts are minimal
 - Sector Exposures: Continue to monitor IT sector portfolio weights while maintaining appropriate diversity across other sectors (i.e. healthcare, industrials, consumer)

2023 Short-Term Tactical Recommendations

- **Capitalize on Opportunities**
 - Market Volatility and Interest Rate Hikes: Continue to review and potentially invest with value-oriented, turnaround, and distressed investment managers
 - Co-Investments: Leverage existing 3rd party co-investment managers and continue to develop LACERS co-investment program
 - Secondaries: Continue building a framework for to address secondary transactions – both on the “buy” and the “sell” side
 - Leverage existing 3rd party relationships to learn more and continue to develop LACERS secondaries program
 - Emerging Managers: Continue targeting high-quality first-time managers / spin-outs / diverse managers

- **Minimize Weaknesses / Counter Threats**
 - Over-Diversification: Continue to trim relationships and consolidate capital with higher-conviction managers
 - Legacy Performance: Continue to consider and lay the groundwork for a portfolio secondary sale when appropriate
 - Co-Investment Program: Implement co-investment program in 2023; program to help increase exposure to high-quality GPs and simultaneously mitigate fees and expenses



LACERS
LA CITY EMPLOYEES'
RETIREMENT SYSTEM



REPORT TO BOARD OF ADMINISTRATION

From: Neil M. Guglielmo, General Manager

Neil M. Guglielmo

MEETING: NOVEMBER 22, 2022

ITEM: VIII - E

SUBJECT: NOTIFICATION OF COMMITMENT OF UP TO \$75 MILLION IN PLATINUM EQUITY CAPITAL PARTNERS VI, L.P.

ACTION: CLOSED: CONSENT: RECEIVE & FILE:

Recommendation

That the Board receive and file this notice of the commitment of up to \$75 million in Platinum Equity Capital Partners VI, L.P.

Executive Summary

Platinum Equity Capital Partners VI, L.P. will focus on control investments in underperforming businesses in North America.

Discussion

Consultant Recommendation

Aksia CA LLC (Aksia), LACERS' Private Equity Consultant, recommended a commitment of up to \$75 million in Platinum Equity Capital Partners VI, L.P. (the Fund), a buyout strategy managed by Platinum Equity Advisors LLC (the GP or Platinum). Fund management and incentive fees are comparable to similar strategies; the GP will invest alongside limited partners, providing alignment of interests. This recommendation is consistent with the Private Equity Program 2022 Strategic Plan adopted by the Board on December 14, 2021.

Background

Platinum was founded in 1995 by Tom Gores, an entrepreneur and business operator who continues to lead the firm today. The GP has offices in Los Angeles (headquarters), New York, Boston, Greenwich, London, and Singapore, and consists of over 270 employees. The firm manages \$36 billion in assets and has completed over 350 acquisitions in a broad range of industries.

LACERS has an existing general partner relationship with Platinum and previously committed a total of \$112.5 million to the following Platinum-sponsored funds:

Fund	Vintage Year	Commitment Amount	Net IRR^{1,2}
Platinum Equity Capital Partners III, L.P.	2011	\$25 million	31.3%
Platinum Equity Capital Partners IV, L.P.	2016	\$15 million	31.1%
Platinum Equity Small Cap Fund, L.P.	2018	\$22.5 million	30.0%
Platinum Equity Capital Partners V, L.P.	2019	\$50 million	49.5%

Investment Thesis

The Fund will focus on control investments in underperforming businesses in North America. Representative transaction types include corporate divestitures, special situations, public-to-private company conversions, and restructurings. The GP will utilize its operational expertise in areas such as accounting and finance, human resources, information technology, and sales and marketing to stabilize the companies and improve valuations. Exit strategies include initial public offerings and sales to financial institutions or strategic partners, such as other private equity firms or large enterprise firms.

Placement Agent

The GP does not outsource its fundraising and does not use placement agents.

Staff Recommendation

Staff concurred with Aksia's recommendation. The commitment has been consummated pursuant to the Discretion in a Box (Roles and Responsibilities) section of the Private Equity Investment Policy; no Board action is required.

Strategic Plan Impact Statement

Investment in Platinum Equity Capital Partners VI, L.P. will allow LACERS to maintain exposure to private equity, pursuant to the Private Equity Program 2022 Strategic Plan, and aligns with the Strategic Plan Goal of optimizing long-term risk adjusted investment returns (Goal IV).

Prepared By: Eduardo Park, Investment Officer II, Investment Division

NMG/RJ/BF/WL/EP:rm

Attachments: 1. Aksia Investment Notification
 2. Discretion in a Box

¹ Performance as of March 31, 2022

² Performance data (1) does not necessarily accurately reflect the current or expected future performance of the Fund(s) or the fair value of LACERS' interest in the Fund(s), (2) should not be used to compare returns among multiple private equity funds and (3) has not been calculated, reviewed, verified or in any way sanctioned or approved by the general partner(s) or manager(s).

Aksia LLC

Platinum Equity Capital Partners VI, L.P.
Investment Notification



www.aksia.com

Platinum Equity Capital Partners VI, L.P.

General Partner	• Platinum Equity Advisors, LLC (the “Firm” or “Platinum”)
Fund	• Platinum Equity Capital Partners VI, L.P. (the “Fund” or “Fund VI”)
Firm Founded	• 1995
Strategy	• North American Buyouts
Sub-Strategy	• North American Buyouts
Geography	• Primarily North America
Team	• ~160 investment professionals
Senior Partners	• Tom Gores, Johnny Lopez, John Diggins, Phil Norment, Bob Wentworth, Stephanie Barter, Robert Wymbys, Jacob Kotzubei, Bryan Kelln, and Louis Sampson
Office Locations	• Beverly Hills, Boston, Greenwich, New York, London, Singapore
Industries	• Generalist
Target Fund Size	• \$12.0 billion
LACERS Investment	• \$75.0 million

Investment Highlights

- The 10 senior investment professionals on Platinum’s Flagship investment team collectively bring more than 200 years of investing and operating experience. Furthermore, they have worked together at the Firm on average for more than two decades.
- The Firm has significant operating resources that are heavily involved in portfolio companies and play a critical role in the Firm’s value creation initiatives at portfolio companies.
- Platinum has significant experience in the value-oriented and turnaround segment of the market.
- Over time, the Firm has generated strong and consistent return, albeit with slightly elevated loss ratios.

Platinum Equity Capital Partners VI, L.P.

Firm and Background

- Platinum was founded in 1995 by Tom Gores and initially invested using capital from its founders and principals.
- The Firm raised its first institutional fund in 2004 and has since raised four additional flagship funds.
- Platinum established a small-cap strategy in 2019 to target lower middle and middle market opportunities and a credit strategy in 2020 to invest in the debt of underperforming and undermanaged companies.
- Today, Platinum continues to be led by Gores and has grown to ~270 total professionals.

Investment Strategy

- Fund VI will seek to primarily make control investments in underperforming, undermanaged, and undervalued middle market and large cap companies based in North America.
- Platinum will pursue investments across a variety of industries, including industrials, technology, consumer, services, materials, education, healthcare, and utilities.
- The Fund is expected to have a total of 15 to 25 investments with equity checks typically ranging between \$150 million and \$2.5 billion. Targeted portfolio companies will have enterprise values of \$500 million to \$5+ billion.
- Post-investment, Platinum's portfolio operations group is leveraged to help implement a broad range of operational and financial improvement initiatives at portfolio companies.

PAST PERFORMANCE IS NOT INDICATIVE OF FUTURE PERFORMANCE.

THESE MATERIALS ARE NOT INTENDED AS AN OFFER TO SELL, OR THE SOLICITATION OF AN OFFER TO PURCHASE, ANY SECURITY. THIS PRESENTATION HAS BEEN PREPARED SOLELY FOR INFORMATIONAL AND DISCUSSION PURPOSES ONLY. THE INFORMATION HEREIN IS NOT INTENDED TO BE COMPLETE AND THE DESCRIPTION OF THE FUND IN THESE MATERIALS IS QUALIFIED IN ITS ENTIRETY BY THE TERMS AND INFORMATION CONTAINED IN THE FUND'S OFFERING DOCUMENTS, INCLUDING, WITHOUT LIMITATION, THE FUND'S PRIVATE PLACEMENT MEMORANDUM, PARTNERSHIP AGREEMENT AND SUBSCRIPTION AGREEMENT ("GOVERNING DOCUMENTS"). NOTHING HEREIN CONSTITUTES OR SHOULD NOT BE CONSTRUED AS INVESTMENT ADVICE.

THE INFORMATION HEREIN IS NOT INTENDED TO PROVIDE, AND SHOULD NOT BE RELIED UPON FOR, ACCOUNTING, TAX OR LEGAL ADVICE. YOU SHOULD CONSULT YOUR TAX, LEGAL AND/OR ACCOUNTING ADVISERS ABOUT ANY MATTERS DISCUSSED HEREIN.

INTERESTS IN THE FUND HAVE NOT BEEN AND WILL NOT BE REGISTERED UNDER ANY STATE OR OTHER SECURITIES LAWS OR THE LAWS OF ANY NON-U.S. JURISDICTION. THE INTERESTS WILL BE OFFERED AND SOLD FOR INVESTMENT ONLY TO QUALIFYING INVESTORS PURSUANT TO THE EXEMPTION FROM THE REGISTRATION REQUIREMENTS OF THE SECURITIES ACT AND IN COMPLIANCE WITH THE APPLICABLE SECURITIES LAWS OF THE STATES AND OTHER JURISDICTIONS (INCLUDING NON-U.S. JURISDICTIONS) WHERE THE OFFERING WILL BE MADE. THERE WILL BE NO PUBLIC MARKET FOR INTERESTS IN THE FUND, AND THERE IS NO OBLIGATION ON THE PART OF ANY PERSON TO REGISTER THE INTERESTS UNDER THE SECURITIES ACT. INTERESTS IN THE FUND MAY NOT BE TRANSFERRED OR RESOLD EXCEPT AS PERMITTED UNDER THE SECURITIES ACT AND ANY APPLICABLE NON-U.S. SECURITIES LAWS, PURSUANT TO REGISTRATION OR AN EXEMPTION THEREFROM. THE TRANSFERABILITY OF THE INTERESTS WILL BE FURTHER RESTRICTED BY THE TERMS OF THE FUND'S GOVERNING DOCUMENTS. INVESTORS SHOULD BE AWARE THAT THEY MAY BE REQUIRED TO BEAR THE FINANCIAL RISKS OF AN INVESTMENT IN THE FUND FOR AN INDEFINITE PERIOD OF TIME.

NONE OF THE INFORMATION CONTAINED HEREIN WAS PREPARED BY THE FUND OR ANY UNDERLYING PORTFOLIO FUNDS IDENTIFIED HEREIN, IF ANY, THE GENERAL PARTNERS THEREOF OR ANY OF THEIR RESPECTIVE AFFILIATES. BY ACCEPTING THESE MATERIALS, YOU HEREBY ACKNOWLEDGE AND AGREE TO ALL OF THE TERMS AND CONDITIONS IN THESE DISCLOSURES.

ARTICLE III. BOARD INVESTMENT POLICIES

Section 5 PRIVATE EQUITY INVESTMENT POLICY

F. Roles and Responsibilities

	Role of the Board	Role of Staff	Role of the Private Equity Consultant
Strategy/Policy	<ul style="list-style-type: none"> Select Private Equity Consultant. Approve asset class funding level. Review and approve the Private Equity Annual Strategic Plan which includes allocation targets and ranges. 	<ul style="list-style-type: none"> In consultation with Private Equity Consultant and General Fund Consultant, develop policies, procedures, guidelines, allocation targets, ranges, assumptions for recommendation to the Board. 	<ul style="list-style-type: none"> Help develop policies, procedures, guidelines, allocation targets, ranges, assumptions for recommendation to the Board.
Investment Management and Monitoring	<ul style="list-style-type: none"> Review quarterly, annual, and other periodic monitoring reports and plans. Review Commitment Notification Reports. 	<ul style="list-style-type: none"> Review quarterly, annual and other periodic monitoring reports prepared by the Private Equity Consultant. Conduct meetings with existing managers periodically. Attend annual partnership meetings when appropriate. Fund capital calls and manage distributions. Review Private Equity Consultant's recommendations on partnership amendments and consents. Execute partnership amendments and consents. Manage and approve the wind-down and/or dissolve private equity fund investment(s) with private equity consultant's concurrence. Manage and execute the sale of partnership interest on the secondary market or to other limited partner(s) or potential buyer(s). Prepare Commitment Notification Reports for Board. 	<ul style="list-style-type: none"> Maintain regular contact with existing managers in the portfolio to ascertain significant events within the portfolio. Recommend amendments and consents to Staff for approval. Provide quarterly, annual, and other periodic monitoring reports and plans.

ARTICLE III. BOARD INVESTMENT POLICIES

Section 5 PRIVATE EQUITY INVESTMENT POLICY

Investment Selection	Role of the Board	Role of Staff	Role of the Private Equity Consultant
	<ul style="list-style-type: none"> • Review investment analysis reports. • Review and approve investments in partnerships of amounts greater than \$150 million prior to investment. • Review and approve direct co-investment opportunities that exceed \$50 million. • Review and approve the sale of any one existing partnership fund on the secondary market exceeding \$50 million in Fair Market Value. • Review and approve a simultaneous sale of multiple partnership fund interests in a packaged structure. 	<ul style="list-style-type: none"> • Refer investments and forward to Private Equity Consultant for preliminary screening. • Conduct meetings with prospective or existing general partners representing new investment opportunities. • Conduct due diligence with general partners to better ascertain risk and return profile, as determined by the Chief Investment Officer. • In conjunction with Private Equity Consultant, invest up to and including \$150 million in partnerships without Board approval. If Staff opposes and Private Equity Consultant disagrees, refer to Board for decision. • In conjunction with Private Equity Consultant, make recommendations to Board for approval for investments over \$150 million. • In conjunction with Private Equity Consultant, review and concur with direct co-investment opportunities up to and including \$50 million. • In conjunction with Private Equity Consultant, review and concur with the approval of sale of existing partnership funds on the secondary market up to and including \$50 million in Fair Market Value. • General Manager or designee with signature authority will execute agreements and other legal or business documents to effectuate the transaction closing. • Ensure review of relevant fund documents by the City Attorney and/or external legal counsel. 	<ul style="list-style-type: none"> • Conduct appropriate analysis and due diligence on investments. • Prepare investment reports for Board consideration on investments exceeding \$150 million. • With Staff concurrence, approve investments of up to and including \$150 million. • With Staff concurrence, approve direct co-investment opportunities up to and including \$50 million. • Present to Staff recommendations pertaining to the sale of existing partnership funds on the secondary market exceeding \$50 million in Fair Market Value. Such transactions shall be brought to the Board for review and approval. • Provide investment analysis reports for each new investment and for sales of partnership fund interest on the secondary market or to other limited partner(s) or potential buyer(s). • Communicate with Staff regarding potential investment opportunities undergoing analysis and due diligence. • Coordinate meetings with general partners at the request of Staff. • Advise on and negotiate investment terms.



LACERS
LA CITY EMPLOYEES'
RETIREMENT SYSTEM



REPORT TO BOARD OF ADMINISTRATION
From: Neil M. Guglielmo, General Manager

MEETING: NOVEMBER 22, 2022
ITEM: VIII - F

Neil M. Guglielmo

SUBJECT: NOTIFICATION OF COMMITMENT OF UP TO \$20 MILLION IN AULDBRASS PARTNERS SECONDARY OPPORTUNITY FUND III, L.P.

ACTION: CLOSED: CONSENT: RECEIVE & FILE:

Recommendation

That the Board receive and file this notice of the commitment of up to \$20 million in Auldbress Partners Secondary Opportunity Fund III, L.P.

Executive Summary

Auldbress Partners Secondary Opportunity Fund III, L.P. will focus on private equity secondary transactions primarily in North America.

Discussion

Consultant Recommendation

Aksia CA LLC (Aksia), LACERS' Private Equity Consultant, recommended a commitment of up to \$20 million in Auldbress Partners Secondary Opportunity Fund III, L.P. (the Fund), a secondaries strategy managed by Auldbress Holdings, LLC (Auldbress or the GP). Fund management and incentive fees are comparable to similar strategies; the GP will invest alongside limited partners, providing alignment of interests. The recommendation is consistent with the Private Equity Program 2022 Strategic Plan adopted by the Board on December 14, 2021.

Background

Howard Sanders founded Auldbress in 2011 after spinning out from Citi Holdings, where he served as Head of Private Investments for Citigroup's pension fund. Auldbress is led by Sanders and Christopher Salley, who are both managing directors, and Vish Apte, who is a principal. The firm is based in New York City and has ten investment professionals.

Auldbress is a new general partner relationship for LACERS and meets the criteria as an Emerging Investment Manager pursuant to the LACERS Emerging Investment Manager Policy.

Investment Thesis

Auldbress acquires secondary interests through both limited partner interests and general partner-led opportunities in middle market buyout, global buyout, and growth equity. The Fund will seek to invest in growth companies through secondary transactions across four verticals: software, education technology, healthcare, and tech-enabled services. Target companies will typically have strong margins, limited leverage, and an achievable exit strategy. The companies will be supported by institutional-quality management teams with alignment of interests. The Fund is expected to invest primarily across North America, with up to 15% permitted for Western Europe.

Placement Agent

The GP did not use a placement agent in connection with LACERS' investment.

Staff Recommendation

Staff concurred with Aksia's recommendation. The commitment has been consummated pursuant to the Discretion in a Box (Roles and Responsibilities) section of the Private Equity Investment Policy; no Board action is required.

Strategic Plan Impact Statement

Investment in Auldbress Partners Secondary Opportunity Fund III, L.P. will allow LACERS to maintain exposure to private equity, pursuant to the Private Equity Program 2022 Strategic Plan, and aligns with the Strategic Plan Goal of optimizing long-term risk adjusted investment returns (Goal IV).

Prepared By: Clark Hoover, Investment Officer I, Investment Division

NMG/RJ/BF/WL/CH:rm

Attachments: 1. Aksia Investment Notification
2. Discretion in a Box

Aksia LLC

Auldbrass Partners Secondary Opportunity Fund III, L.P. Investment Notification



www.aksia.com



Auldbress Partners Secondary Opportunity Fund III, L.P.

General Partner	• Auldbress Holdings, LLC (“Auldbress” or the “Firm”)
Fund	• Auldbress Partners Secondary Opportunity Fund III, L.P. (“Fund III”)
Firm Founded	• 2011
Strategy	• PE Secondaries
Sub-Strategy	• PE Secondaries
Geography	• North America
Team	• ~10 investment professionals
Senior Partners	• Howard Sanders, Christopher Salley (Managing Directors), Vish Apte (Principal)
Office Locations	• New York, NY
Industries	• Software, Tech-Enabled Services, Edtech, and Healthcare
Target Fund Size	• \$200.0 million
LACERS Investment	• \$20.0 million

Investment Highlights

- The Firm’s three senior professionals have an average of nearly 10 years working together and a collective 74 years of investment experience.
- Auldbress employs a flexible investment strategy that allows the Fund to underwrite opportunities ranging from traditional secondaries to GP-led transactions, including continuation vehicles and direct secondaries.
- The Firm has a demonstrated history of deploying capital within the stated strategy and the returns to date have been positive.

Auldbress Partners Secondary Opportunity Fund III, L.P.

Firm and Background

- Auldbress was founded by Howard Sanders in 2011 after spinning out from Citi Holdings. The Firm initially had a mandate to manage a portfolio of existing private equity, real estate, and hedge funds. Prior to the spin out, Sanders was the Head of Private Investments for Citigroup's multi-billion-dollar pension fund.
- From 2011 to 2016, Auldbress evolved from monitoring a large existing portfolio to pricing and acquiring new and unique secondary investments.
- In 2016 Auldbress launched Auldbress Partners Secondary Opportunity Fund II, which raised \$92.5 million in total commitments.

Investment Strategy

- Auldbress employs a flexible investment strategy that allows the Fund to underwrite opportunities ranging from traditional secondaries to GP-led transactions, including continuation vehicles and direct secondaries.
- The Fund is expected to consist of 20 to 30 transactions with approximately 65.0% in GP-led transactions and 35.0% in traditional LP secondary transactions. Target investments will likely require equity checks of \$20.0 million or less.
- Fund III will seek to invest in growth companies through secondary transactions across four verticals: software, edtech, healthcare, and tech-enabled services.
- The Fund is expected to be primarily invested across North America, however, up to 15.0% may be invested in Western Europe.

PAST PERFORMANCE IS NOT INDICATIVE OF FUTURE PERFORMANCE.

THESE MATERIALS ARE NOT INTENDED AS AN OFFER TO SELL, OR THE SOLICITATION OF AN OFFER TO PURCHASE, ANY SECURITY. THIS PRESENTATION HAS BEEN PREPARED SOLELY FOR INFORMATIONAL AND DISCUSSION PURPOSES ONLY. THE INFORMATION HEREIN IS NOT INTENDED TO BE COMPLETE AND THE DESCRIPTION OF THE FUND IN THESE MATERIALS IS QUALIFIED IN ITS ENTIRETY BY THE TERMS AND INFORMATION CONTAINED IN THE FUND'S OFFERING DOCUMENTS, INCLUDING, WITHOUT LIMITATION, THE FUND'S PRIVATE PLACEMENT MEMORANDUM, PARTNERSHIP AGREEMENT AND SUBSCRIPTION AGREEMENT ("GOVERNING DOCUMENTS"). NOTHING HEREIN CONSTITUTES OR SHOULD NOT BE CONSTRUED AS INVESTMENT ADVICE.

THE INFORMATION HEREIN IS NOT INTENDED TO PROVIDE, AND SHOULD NOT BE RELIED UPON FOR, ACCOUNTING, TAX OR LEGAL ADVICE. YOU SHOULD CONSULT YOUR TAX, LEGAL AND/OR ACCOUNTING ADVISERS ABOUT ANY MATTERS DISCUSSED HEREIN.

INTERESTS IN THE FUND HAVE NOT BEEN AND WILL NOT BE REGISTERED UNDER ANY STATE OR OTHER SECURITIES LAWS OR THE LAWS OF ANY NON-U.S. JURISDICTION. THE INTERESTS WILL BE OFFERED AND SOLD FOR INVESTMENT ONLY TO QUALIFYING INVESTORS PURSUANT TO THE EXEMPTION FROM THE REGISTRATION REQUIREMENTS OF THE SECURITIES ACT AND IN COMPLIANCE WITH THE APPLICABLE SECURITIES LAWS OF THE STATES AND OTHER JURISDICTIONS (INCLUDING NON-U.S. JURISDICTIONS) WHERE THE OFFERING WILL BE MADE. THERE WILL BE NO PUBLIC MARKET FOR INTERESTS IN THE FUND, AND THERE IS NO OBLIGATION ON THE PART OF ANY PERSON TO REGISTER THE INTERESTS UNDER THE SECURITIES ACT. INTERESTS IN THE FUND MAY NOT BE TRANSFERRED OR RESOLD EXCEPT AS PERMITTED UNDER THE SECURITIES ACT AND ANY APPLICABLE NON-U.S. SECURITIES LAWS, PURSUANT TO REGISTRATION OR AN EXEMPTION THEREFROM. THE TRANSFERABILITY OF THE INTERESTS WILL BE FURTHER RESTRICTED BY THE TERMS OF THE FUND'S GOVERNING DOCUMENTS. INVESTORS SHOULD BE AWARE THAT THEY MAY BE REQUIRED TO BEAR THE FINANCIAL RISKS OF AN INVESTMENT IN THE FUND FOR AN INDEFINITE PERIOD OF TIME.

NONE OF THE INFORMATION CONTAINED HEREIN WAS PREPARED BY THE FUND OR ANY UNDERLYING PORTFOLIO FUNDS IDENTIFIED HEREIN, IF ANY, THE GENERAL PARTNERS THEREOF OR ANY OF THEIR RESPECTIVE AFFILIATES. BY ACCEPTING THESE MATERIALS, YOU HEREBY ACKNOWLEDGE AND AGREE TO ALL OF THE TERMS AND CONDITIONS IN THESE DISCLOSURES.

ARTICLE III. BOARD INVESTMENT POLICIES

Section 5 PRIVATE EQUITY INVESTMENT POLICY

F. Roles and Responsibilities

	Role of the Board	Role of Staff	Role of the Private Equity Consultant
Strategy/Policy	<ul style="list-style-type: none"> Select Private Equity Consultant. Approve asset class funding level. Review and approve the Private Equity Annual Strategic Plan which includes allocation targets and ranges. 	<ul style="list-style-type: none"> In consultation with Private Equity Consultant and General Fund Consultant, develop policies, procedures, guidelines, allocation targets, ranges, assumptions for recommendation to the Board. 	<ul style="list-style-type: none"> Help develop policies, procedures, guidelines, allocation targets, ranges, assumptions for recommendation to the Board.
Investment Management and Monitoring	<ul style="list-style-type: none"> Review quarterly, annual, and other periodic monitoring reports and plans. Review Commitment Notification Reports. 	<ul style="list-style-type: none"> Review quarterly, annual and other periodic monitoring reports prepared by the Private Equity Consultant. Conduct meetings with existing managers periodically. Attend annual partnership meetings when appropriate. Fund capital calls and manage distributions. Review Private Equity Consultant's recommendations on partnership amendments and consents. Execute partnership amendments and consents. Manage and approve the wind-down and/or dissolve private equity fund investment(s) with private equity consultant's concurrence. Manage and execute the sale of partnership interest on the secondary market or to other limited partner(s) or potential buyer(s). Prepare Commitment Notification Reports for Board. 	<ul style="list-style-type: none"> Maintain regular contact with existing managers in the portfolio to ascertain significant events within the portfolio. Recommend amendments and consents to Staff for approval. Provide quarterly, annual, and other periodic monitoring reports and plans.

ARTICLE III. BOARD INVESTMENT POLICIES

Section 5 PRIVATE EQUITY INVESTMENT POLICY

Investment Selection	Role of the Board	Role of Staff	Role of the Private Equity Consultant
	<ul style="list-style-type: none"> • Review investment analysis reports. • Review and approve investments in partnerships of amounts greater than \$150 million prior to investment. • Review and approve direct co-investment opportunities that exceed \$50 million. • Review and approve the sale of any one existing partnership fund on the secondary market exceeding \$50 million in Fair Market Value. • Review and approve a simultaneous sale of multiple partnership fund interests in a packaged structure. 	<ul style="list-style-type: none"> • Refer investments and forward to Private Equity Consultant for preliminary screening. • Conduct meetings with prospective or existing general partners representing new investment opportunities. • Conduct due diligence with general partners to better ascertain risk and return profile, as determined by the Chief Investment Officer. • In conjunction with Private Equity Consultant, invest up to and including \$150 million in partnerships without Board approval. If Staff opposes and Private Equity Consultant disagrees, refer to Board for decision. • In conjunction with Private Equity Consultant, make recommendations to Board for approval for investments over \$150 million. • In conjunction with Private Equity Consultant, review and concur with direct co-investment opportunities up to and including \$50 million. • In conjunction with Private Equity Consultant, review and concur with the approval of sale of existing partnership funds on the secondary market up to and including \$50 million in Fair Market Value. • General Manager or designee with signature authority will execute agreements and other legal or business documents to effectuate the transaction closing. • Ensure review of relevant fund documents by the City Attorney and/or external legal counsel. 	<ul style="list-style-type: none"> • Conduct appropriate analysis and due diligence on investments. • Prepare investment reports for Board consideration on investments exceeding \$150 million. • With Staff concurrence, approve investments of up to and including \$150 million. • With Staff concurrence, approve direct co-investment opportunities up to and including \$50 million. • Present to Staff recommendations pertaining to the sale of existing partnership funds on the secondary market exceeding \$50 million in Fair Market Value. Such transactions shall be brought to the Board for review and approval. • Provide investment analysis reports for each new investment and for sales of partnership fund interest on the secondary market or to other limited partner(s) or potential buyer(s). • Communicate with Staff regarding potential investment opportunities undergoing analysis and due diligence. • Coordinate meetings with general partners at the request of Staff. • Advise on and negotiate investment terms.



LACERS
LA CITY EMPLOYEES'
RETIREMENT SYSTEM



REPORT TO BOARD OF ADMINISTRATION

From: Neil M. Guglielmo, General Manager

Neil M. Guglielmo

MEETING: NOVEMBER 22, 2022

ITEM: VIII - G

SUBJECT: NOTIFICATION OF COMMITMENT OF UP TO €71.0 MILLION (APPROXIMATELY \$75.0 MILLION) IN EIGHTH CINVEN FUND (NO. 1) LIMITED PARTNERSHIP

ACTION: CLOSED: CONSENT: RECEIVE & FILE:

Recommendation

That the Board receive and file this notice of the commitment of up to €71.0 million (approximately \$75.0 million) in Eighth Cinven Fund (No. 1) Limited Partnership.

Executive Summary

Eighth Cinven Fund (No. 1) Limited Partnership will focus on control investments in large businesses located primarily in the U.K., Germany, Southern Europe, and the United States.

Discussion

Consultant Recommendation

Aksia CA LLC (Aksia), LACERS' Private Equity Consultant, recommended a commitment of up to €71.0 million in Eighth Cinven Fund (No. 1) Limited Partnership (the Fund), a buyout strategy managed by Cinven Limited (the Firm or Cinven). Fund management and incentive fees are comparable to similar strategies; the GP will invest alongside limited partners, providing alignment of interest. This recommendation is consistent with the Private Equity Program 2022 Strategic Plan adopted by the Board on December 14, 2021.

Background

Cinven was founded in 1977 as the private equity arm of the British Coal Staff Superannuation Scheme, and in 1995 the management team bought out the business to form an independent company. The firm is currently led by Managing Partner Stuart McAlpine, who joined the firm in 1996. The firm's Executive Committee also includes Alexandra Hess, Bruno Schick, Caspar Berendsen, Jorge Quemada, Matthew Sabben-Clare, and Supraj Rajagopalan. Cinven employs more than 115 investment professionals in offices located in London (headquarters), Frankfurt, Milan, Paris, Madrid, and New York.

Cinven is a new general partner relationship for LACERS.

Investment Thesis

The Fund will target large and mature cash generative western European businesses with enterprise values of more than €400 million and will also target U.S.-based businesses that would benefit from European expansion. Cinven focuses on the following sectors: business services; consumer; financial services; healthcare; industrials; and technology, media, and telecommunications. Cinven's value creation plans typically include improving operations, internationalization, developing new products and technology, and investing for growth through a buy-and-build strategy. Transactions typically will take the form of leveraged buyouts, division carve-outs, and take-privates. Exit strategies include initial public offerings and sales to financial institutions or strategic partners, such as other private equity firms or large enterprise firms

Placement Agent

The GP did not use a placement agent in connection with LACERS' investment.

Staff Recommendation

Staff concurred with Aksia's recommendation. The commitment has been consummated pursuant to the Discretion in a Box (Roles and Responsibilities) section of the Private Equity Investment Policy; no Board action is required.

Strategic Plan Impact Statement

Investment in the Eighth Cinven Fund (No. 1) Limited Partnership will allow LACERS to maintain exposure to private equity, pursuant to the Private Equity Program 2022 Strategic Plan, and aligns with the Strategic Plan Goal of optimizing long-term risk adjusted investment returns (Goal IV).

Prepared By: Robert King, Investment Officer II, Investment Division

NMG/RJ/BF/WL/RK:rm

Attachments: 1. Aksia Investment Notification
 2. Discretion in a Box

Aksia LLC

Eighth Cinven Fund (No. 1) Limited Partnership Investment Notification



www.aksia.com



Eighth Cinven Fund (No. 1) Limited Partnership

General Partner	• Cinven Limited (“Cinven” or the “Firm”)
Fund	• Eighth Cinven Fund (No. 1) Limited Partnership (the “Fund” or “Fund VIII”)
Firm Founded	• 1977
Strategy	• European Buyouts
Sub-Strategy	• European Buyouts
Geography	• Primarily Europe
Team	• ~115 investment professionals
Senior Partners	• Stuart McAlpine, David Barker, Supraj Rajagopalan, Jorge Quemada, Caspar Berendsen, Bruno Schick, Maxim Crewe, Pontus Pettersson
Office Locations	• London, Paris, Frankfurt, Milan, Madrid, New York
Industries	• Business Services; Consumer; Financial Services; Healthcare; Industrials; and TMT.
Target Fund Size	• €12.0 billion
LACERS Investment	• €71.0 million

Investment Highlights

- The Fund will be managed by a large group of 31 Partners that collectively have over 650 years of private equity experience and have an average tenure of approximately 14 years at Cinven.
- The Firm has demonstrated the ability to grow underlying portfolio companies through add-on acquisitions.
- The Firm’s prior funds have generated consistently positive returns, with low loss ratios.
- The Firm has demonstrated the ability to realize investments and return capital to investors.

Eighth Cinven Fund (No. 1) Limited Partnership

Firm and Background

- Cinven was founded in 1977 as the private equity arm of the British Coal Staff Superannuation Scheme. The Firm's original leadership team completed a management buyout in 1995 and subsequently raised €1.6 billion for its first formal fund in 1996.
- The Firm is currently led by Stuart McAlpine, who joined Cinven in 1996 and was promoted to Managing Partner in 2016. He is supported by a large team of 30 Partners and a broader investment team comprised of 40+ Principals and 40+ Associates.

Investment Strategy

- The Firm has a pan-European mandate and has been the most active in the U.K., Germany, Southern Europe. The Firm has only been active in the U.S. more recently.
- The Firm is organized around six industry verticals: (i) Business Services; (ii) Consumer; (iii) Financial Services; (iv) Healthcare; (v) Industrials; and (vi) TMT.
- The Fund will be comprised of 15 to 20 upper-middle-market companies that require post-syndication equity checks between €300 million and €1.5 billion per platform.
- Targeted companies will have enterprise values of €400 million or more. The median enterprise value in Fund 6 and Fund 7 was €845 million and €2.8 billion, respectively.
- Transactions are expected to take the form of primary buyouts, secondary buyouts, corporate carve-outs, and take-privates, with an emphasis on carve-out and take-private opportunities. The Firm will almost exclusively target control or joint control of businesses in order to implement its value creation plan.



PAST PERFORMANCE IS NOT INDICATIVE OF FUTURE PERFORMANCE.

THESE MATERIALS ARE NOT INTENDED AS AN OFFER TO SELL, OR THE SOLICITATION OF AN OFFER TO PURCHASE, ANY SECURITY. THIS PRESENTATION HAS BEEN PREPARED SOLELY FOR INFORMATIONAL AND DISCUSSION PURPOSES ONLY. THE INFORMATION HEREIN IS NOT INTENDED TO BE COMPLETE AND THE DESCRIPTION OF THE FUND IN THESE MATERIALS IS QUALIFIED IN ITS ENTIRETY BY THE TERMS AND INFORMATION CONTAINED IN THE FUND'S OFFERING DOCUMENTS, INCLUDING, WITHOUT LIMITATION, THE FUND'S PRIVATE PLACEMENT MEMORANDUM, PARTNERSHIP AGREEMENT AND SUBSCRIPTION AGREEMENT ("GOVERNING DOCUMENTS"). NOTHING HEREIN CONSTITUTES OR SHOULD NOT BE CONSTRUED AS INVESTMENT ADVICE.

THE INFORMATION HEREIN IS NOT INTENDED TO PROVIDE, AND SHOULD NOT BE RELIED UPON FOR, ACCOUNTING, TAX OR LEGAL ADVICE. YOU SHOULD CONSULT YOUR TAX, LEGAL AND/OR ACCOUNTING ADVISERS ABOUT ANY MATTERS DISCUSSED HEREIN.

INTERESTS IN THE FUND HAVE NOT BEEN AND WILL NOT BE REGISTERED UNDER ANY STATE OR OTHER SECURITIES LAWS OR THE LAWS OF ANY NON-U.S. JURISDICTION. THE INTERESTS WILL BE OFFERED AND SOLD FOR INVESTMENT ONLY TO QUALIFYING INVESTORS PURSUANT TO THE EXEMPTION FROM THE REGISTRATION REQUIREMENTS OF THE SECURITIES ACT AND IN COMPLIANCE WITH THE APPLICABLE SECURITIES LAWS OF THE STATES AND OTHER JURISDICTIONS (INCLUDING NON-U.S. JURISDICTIONS) WHERE THE OFFERING WILL BE MADE. THERE WILL BE NO PUBLIC MARKET FOR INTERESTS IN THE FUND, AND THERE IS NO OBLIGATION ON THE PART OF ANY PERSON TO REGISTER THE INTERESTS UNDER THE SECURITIES ACT. INTERESTS IN THE FUND MAY NOT BE TRANSFERRED OR RESOLD EXCEPT AS PERMITTED UNDER THE SECURITIES ACT AND ANY APPLICABLE NON-U.S. SECURITIES LAWS, PURSUANT TO REGISTRATION OR AN EXEMPTION THEREFROM. THE TRANSFERABILITY OF THE INTERESTS WILL BE FURTHER RESTRICTED BY THE TERMS OF THE FUND'S GOVERNING DOCUMENTS. INVESTORS SHOULD BE AWARE THAT THEY MAY BE REQUIRED TO BEAR THE FINANCIAL RISKS OF AN INVESTMENT IN THE FUND FOR AN INDEFINITE PERIOD OF TIME.

NONE OF THE INFORMATION CONTAINED HEREIN WAS PREPARED BY THE FUND OR ANY UNDERLYING PORTFOLIO FUNDS IDENTIFIED HEREIN, IF ANY, THE GENERAL PARTNERS THEREOF OR ANY OF THEIR RESPECTIVE AFFILIATES. BY ACCEPTING THESE MATERIALS, YOU HEREBY ACKNOWLEDGE AND AGREE TO ALL OF THE TERMS AND CONDITIONS IN THESE DISCLOSURES.

ARTICLE III. BOARD INVESTMENT POLICIES

Section 5 PRIVATE EQUITY INVESTMENT POLICY

F. Roles and Responsibilities

	Role of the Board	Role of Staff	Role of the Private Equity Consultant
Strategy/Policy	<ul style="list-style-type: none"> Select Private Equity Consultant. Approve asset class funding level. Review and approve the Private Equity Annual Strategic Plan which includes allocation targets and ranges. 	<ul style="list-style-type: none"> In consultation with Private Equity Consultant and General Fund Consultant, develop policies, procedures, guidelines, allocation targets, ranges, assumptions for recommendation to the Board. 	<ul style="list-style-type: none"> Help develop policies, procedures, guidelines, allocation targets, ranges, assumptions for recommendation to the Board.
Investment Management and Monitoring	<ul style="list-style-type: none"> Review quarterly, annual, and other periodic monitoring reports and plans. Review Commitment Notification Reports. 	<ul style="list-style-type: none"> Review quarterly, annual and other periodic monitoring reports prepared by the Private Equity Consultant. Conduct meetings with existing managers periodically. Attend annual partnership meetings when appropriate. Fund capital calls and manage distributions. Review Private Equity Consultant's recommendations on partnership amendments and consents. Execute partnership amendments and consents. Manage and approve the wind-down and/or dissolve private equity fund investment(s) with private equity consultant's concurrence. Manage and execute the sale of partnership interest on the secondary market or to other limited partner(s) or potential buyer(s). Prepare Commitment Notification Reports for Board. 	<ul style="list-style-type: none"> Maintain regular contact with existing managers in the portfolio to ascertain significant events within the portfolio. Recommend amendments and consents to Staff for approval. Provide quarterly, annual, and other periodic monitoring reports and plans.

ARTICLE III. BOARD INVESTMENT POLICIES

Section 5 PRIVATE EQUITY INVESTMENT POLICY

	Role of the Board	Role of Staff	Role of the Private Equity Consultant
Investment Selection	<ul style="list-style-type: none"> Review investment analysis reports. Review and approve investments in partnerships of amounts greater than \$150 million prior to investment. Review and approve direct co-investment opportunities that exceed \$50 million. Review and approve the sale of any one existing partnership fund on the secondary market exceeding \$50 million in Fair Market Value. Review and approve a simultaneous sale of multiple partnership fund interests in a packaged structure. 	<ul style="list-style-type: none"> Refer investments and forward to Private Equity Consultant for preliminary screening. Conduct meetings with prospective or existing general partners representing new investment opportunities. Conduct due diligence with general partners to better ascertain risk and return profile, as determined by the Chief Investment Officer. In conjunction with Private Equity Consultant, invest up to and including \$150 million in partnerships without Board approval. If Staff opposes and Private Equity Consultant disagrees, refer to Board for decision. In conjunction with Private Equity Consultant, make recommendations to Board for approval for investments over \$150 million. In conjunction with Private Equity Consultant, review and concur with direct co-investment opportunities up to and including \$50 million. In conjunction with Private Equity Consultant, review and concur with the approval of sale of existing partnership funds on the secondary market up to and including \$50 million in Fair Market Value. General Manager or designee with signature authority will execute agreements and other legal or business documents to effectuate the transaction closing. Ensure review of relevant fund documents by the City Attorney and/or external legal counsel. 	<ul style="list-style-type: none"> Conduct appropriate analysis and due diligence on investments. Prepare investment reports for Board consideration on investments exceeding \$150 million. With Staff concurrence, approve investments of up to and including \$150 million. With Staff concurrence, approve direct co-investment opportunities up to and including \$50 million. Present to Staff recommendations pertaining to the sale of existing partnership funds on the secondary market exceeding \$50 million in Fair Market Value. Such transactions shall be brought to the Board for review and approval. Provide investment analysis reports for each new investment and for sales of partnership fund interest on the secondary market or to other limited partner(s) or potential buyer(s). Communicate with Staff regarding potential investment opportunities undergoing analysis and due diligence. Coordinate meetings with general partners at the request of Staff. Advise on and negotiate investment terms.



REPORT TO BOARD OF ADMINISTRATION

From: Neil M. Guglielmo, General Manager

Neil M. Guglielmo

MEETING: NOVEMBER 22, 2022

ITEM: VIII - H

SUBJECT: NOTIFICATION OF COMMITMENT OF UP TO \$20 MILLION IN SUNSTONE PARTNERS III-MAIN, LP

ACTION: CLOSED: CONSENT: RECEIVE & FILE:

Recommendation

That the Board receive and file this notice of the commitment of up to \$20 million in Sunstone Partners III-Main, LP

Executive Summary

Sunstone Partners III-Main, LP will focus on growth equity investments in technology-enabled services and software companies in North America.

Discussion

Consultant Recommendation

Aksia CA LLC (Aksia), LACERS' Private Equity Consultant, recommended a commitment of up to \$20 million in Sunstone Partners III-Main, LP (the Fund), a growth equity strategy managed by Sunstone Partners Management, LLC (the GP or Sunstone). Fund management and incentive fees are comparable to similar strategies; the GP will invest alongside limited partners, providing alignment of interests. This recommendation is consistent with the Private Equity Program 2022 Strategic Plan adopted by the Board on December 14, 2021.

Background

Sunstone Partners (formerly known as TC Growth Partners) was founded in 2015 by Gustavo Alberelli, Michael Biggee, and Arneek Multani (collectively, the Partners). The Partners previously worked together as the growth equity team at Trident Capital, a multi-stage venture capital firm. The firm employs 15 investment professionals, located in San Mateo, California.

Sunstone Partners is an existing general partner relationship for LACERS and meets the criteria as an Emerging Investment Manager pursuant to the LACERS Emerging Investment Manager Policy. LACERS previously committed a total of \$17.5 million to the following Sunstone-sponsored funds:

Fund	Vintage Year	Commitment Amount	Net IRR^{1,2}
Sunstone Partners I	2015	\$7.5 million	38.9%
Sunstone Partners II	2020	\$10 million	62.2%

Investment Thesis

Sunstone Partners will target growth equity investments in lower-middle market, technology-enabled services companies based in North America. The GP will focus on companies providing enterprise solutions in the healthcare information technology, marketing services, enterprise information technology, and cyber security sectors. These companies typically will be profitable with more than \$15 million in annual revenue run rates and 20% in year-over-year annual revenue growth. The GP adds value to portfolio companies by providing capital as well as strategic and operational guidance to achieve growth in revenues, profitability, and market share. The portfolio operations team adds further value by working alongside portfolio company management teams to execute strategic plans. Exit strategies include sales to financial institutions or strategic partners, such as other private equity firms or large enterprise firms.

Placement Agent

The GP does not outsource its fundraising and does not use placement agents.

Staff Recommendation

Staff concurred with Aksia's recommendation. The commitment has been consummated pursuant to the Discretion in a Box (Roles and Responsibilities) section of the Private Equity Investment Policy; no Board action is required.

Strategic Plan Impact Statement

Investment in Sunstone Partners III-Main, LP will allow LACERS to maintain exposure to private equity, pursuant to the Private Equity Program 2022 Strategic Plan, and aligns with the Strategic Plan Goal of optimizing long-term risk adjusted investment returns (Goal IV).

Prepared By: Eduardo Park, Investment Officer II, Investment Division

NMG/RJ/BF/WL/EP:rm

Attachments: 1. Aksia Investment Notification
 2. Discretion in a Box

¹ Performance as of March 31, 2022

² Performance data (1) does not necessarily accurately reflect the current or expected future performance of the Fund(s) or the fair value of LACERS' interest in the Fund(s), (2) should not be used to compare returns among multiple private equity funds and (3) has not been calculated, reviewed, verified or in any way sanctioned or approved by the general partner(s) or manager(s).

Aksia LLC

Sunstone Partners III-Main, LP Investment Notification



www.aksia.com



Sunstone Partners III-Main, LP

General Partner	• Sunstone Partners Management, LLC (the “Firm” or “Sunstone”)
Fund	• Sunstone Partners III-Main, LP (“Fund III”)
Firm Founded	• 2015
Strategy	• Growth Equity
Sub-Strategy	• Growth Equity
Geography	• North America
Team	• ~15 investment professionals
Senior Partners	• Gustavo Alberelli, Michael Biggee, and Arneek Multani (Managing Partners)
Office Locations	• San Mateo, CA
Industries	• Technology Enabled Services: (i) cybersecurity, (ii) healthcare IT, (iii) cloud, (iv) marketing services
Target Fund Size	• \$850.0 million
LACERS Investment	• \$20.0 million

Investment Highlights

- Experienced and cohesive senior team that worked together for a number of years prior to forming Sunstone and have collectively managed the Firm for more than 7 years at this point.
- For well over a decade, the Managing Partners have consistently targeted a narrow set of specialized subsectors within tech-enabled services.
- Strong prior track record with few losses.

Sunstone Partners III, L.P.

Firm and Background

- Sunstone was founded in 2015 as a spin-out of the growth equity team from Trident Capital.
- The Firm is currently led by three Managing Partners who have been with Sunstone since its founding and have prior experience working together at Trident Capital.
- Leadership is supported by a fast-growing team currently consisting of three Principals, four Vice Presidents, six Associates, and two additional Operating Partners.

Investment Strategy

- The Fund will pursue majority and significant minority investments in companies that offer technology-enabled services to enterprises within the cloud, cybersecurity, healthcare IT, and marketing services segments in North America.
- Targeted companies will be profitable or breakeven with demonstrated annual revenue run rates of at least \$15.0 million per year and a growth rate of 20.0% or greater.
- The Fund will seek to make 10 or more investments with an average investment size between \$40.0 million and \$100.0 million through both controlling and significant minority stakes.
- Ideal companies will be those that leverage proprietary software to automate business processes and improve operational efficiencies, particularly those with a recurring subscription model.

PAST PERFORMANCE IS NOT INDICATIVE OF FUTURE PERFORMANCE.

THESE MATERIALS ARE NOT INTENDED AS AN OFFER TO SELL, OR THE SOLICITATION OF AN OFFER TO PURCHASE, ANY SECURITY. THIS PRESENTATION HAS BEEN PREPARED SOLELY FOR INFORMATIONAL AND DISCUSSION PURPOSES ONLY. THE INFORMATION HEREIN IS NOT INTENDED TO BE COMPLETE AND THE DESCRIPTION OF THE FUND IN THESE MATERIALS IS QUALIFIED IN ITS ENTIRETY BY THE TERMS AND INFORMATION CONTAINED IN THE FUND'S OFFERING DOCUMENTS, INCLUDING, WITHOUT LIMITATION, THE FUND'S PRIVATE PLACEMENT MEMORANDUM, PARTNERSHIP AGREEMENT AND SUBSCRIPTION AGREEMENT ("GOVERNING DOCUMENTS"). NOTHING HEREIN CONSTITUTES OR SHOULD NOT BE CONSTRUED AS INVESTMENT ADVICE.

THE INFORMATION HEREIN IS NOT INTENDED TO PROVIDE, AND SHOULD NOT BE RELIED UPON FOR, ACCOUNTING, TAX OR LEGAL ADVICE. YOU SHOULD CONSULT YOUR TAX, LEGAL AND/OR ACCOUNTING ADVISERS ABOUT ANY MATTERS DISCUSSED HEREIN.

INTERESTS IN THE FUND HAVE NOT BEEN AND WILL NOT BE REGISTERED UNDER ANY STATE OR OTHER SECURITIES LAWS OR THE LAWS OF ANY NON-U.S. JURISDICTION. THE INTERESTS WILL BE OFFERED AND SOLD FOR INVESTMENT ONLY TO QUALIFYING INVESTORS PURSUANT TO THE EXEMPTION FROM THE REGISTRATION REQUIREMENTS OF THE SECURITIES ACT AND IN COMPLIANCE WITH THE APPLICABLE SECURITIES LAWS OF THE STATES AND OTHER JURISDICTIONS (INCLUDING NON-U.S. JURISDICTIONS) WHERE THE OFFERING WILL BE MADE. THERE WILL BE NO PUBLIC MARKET FOR INTERESTS IN THE FUND, AND THERE IS NO OBLIGATION ON THE PART OF ANY PERSON TO REGISTER THE INTERESTS UNDER THE SECURITIES ACT. INTERESTS IN THE FUND MAY NOT BE TRANSFERRED OR RESOLD EXCEPT AS PERMITTED UNDER THE SECURITIES ACT AND ANY APPLICABLE NON-U.S. SECURITIES LAWS, PURSUANT TO REGISTRATION OR AN EXEMPTION THEREFROM. THE TRANSFERABILITY OF THE INTERESTS WILL BE FURTHER RESTRICTED BY THE TERMS OF THE FUND'S GOVERNING DOCUMENTS. INVESTORS SHOULD BE AWARE THAT THEY MAY BE REQUIRED TO BEAR THE FINANCIAL RISKS OF AN INVESTMENT IN THE FUND FOR AN INDEFINITE PERIOD OF TIME.

NONE OF THE INFORMATION CONTAINED HEREIN WAS PREPARED BY THE FUND OR ANY UNDERLYING PORTFOLIO FUNDS IDENTIFIED HEREIN, IF ANY, THE GENERAL PARTNERS THEREOF OR ANY OF THEIR RESPECTIVE AFFILIATES. BY ACCEPTING THESE MATERIALS, YOU HEREBY ACKNOWLEDGE AND AGREE TO ALL OF THE TERMS AND CONDITIONS IN THESE DISCLOSURES.

ARTICLE III. BOARD INVESTMENT POLICIES

Section 5 PRIVATE EQUITY INVESTMENT POLICY

F. Roles and Responsibilities

	Role of the Board	Role of Staff	Role of the Private Equity Consultant
Strategy/Policy	<ul style="list-style-type: none"> Select Private Equity Consultant. Approve asset class funding level. Review and approve the Private Equity Annual Strategic Plan which includes allocation targets and ranges. 	<ul style="list-style-type: none"> In consultation with Private Equity Consultant and General Fund Consultant, develop policies, procedures, guidelines, allocation targets, ranges, assumptions for recommendation to the Board. 	<ul style="list-style-type: none"> Help develop policies, procedures, guidelines, allocation targets, ranges, assumptions for recommendation to the Board.
Investment Management and Monitoring	<ul style="list-style-type: none"> Review quarterly, annual, and other periodic monitoring reports and plans. Review Commitment Notification Reports. 	<ul style="list-style-type: none"> Review quarterly, annual and other periodic monitoring reports prepared by the Private Equity Consultant. Conduct meetings with existing managers periodically. Attend annual partnership meetings when appropriate. Fund capital calls and manage distributions. Review Private Equity Consultant's recommendations on partnership amendments and consents. Execute partnership amendments and consents. Manage and approve the wind-down and/or dissolve private equity fund investment(s) with private equity consultant's concurrence. Manage and execute the sale of partnership interest on the secondary market or to other limited partner(s) or potential buyer(s). Prepare Commitment Notification Reports for Board. 	<ul style="list-style-type: none"> Maintain regular contact with existing managers in the portfolio to ascertain significant events within the portfolio. Recommend amendments and consents to Staff for approval. Provide quarterly, annual, and other periodic monitoring reports and plans.

ARTICLE III. BOARD INVESTMENT POLICIES

Section 5 PRIVATE EQUITY INVESTMENT POLICY

Investment Selection	Role of the Board	Role of Staff	Role of the Private Equity Consultant
	<ul style="list-style-type: none"> • Review investment analysis reports. • Review and approve investments in partnerships of amounts greater than \$150 million prior to investment. • Review and approve direct co-investment opportunities that exceed \$50 million. • Review and approve the sale of any one existing partnership fund on the secondary market exceeding \$50 million in Fair Market Value. • Review and approve a simultaneous sale of multiple partnership fund interests in a packaged structure. 	<ul style="list-style-type: none"> • Refer investments and forward to Private Equity Consultant for preliminary screening. • Conduct meetings with prospective or existing general partners representing new investment opportunities. • Conduct due diligence with general partners to better ascertain risk and return profile, as determined by the Chief Investment Officer. • In conjunction with Private Equity Consultant, invest up to and including \$150 million in partnerships without Board approval. If Staff opposes and Private Equity Consultant disagrees, refer to Board for decision. • In conjunction with Private Equity Consultant, make recommendations to Board for approval for investments over \$150 million. • In conjunction with Private Equity Consultant, review and concur with direct co-investment opportunities up to and including \$50 million. • In conjunction with Private Equity Consultant, review and concur with the approval of sale of existing partnership funds on the secondary market up to and including \$50 million in Fair Market Value. • General Manager or designee with signature authority will execute agreements and other legal or business documents to effectuate the transaction closing. • Ensure review of relevant fund documents by the City Attorney and/or external legal counsel. 	<ul style="list-style-type: none"> • Conduct appropriate analysis and due diligence on investments. • Prepare investment reports for Board consideration on investments exceeding \$150 million. • With Staff concurrence, approve investments of up to and including \$150 million. • With Staff concurrence, approve direct co-investment opportunities up to and including \$50 million. • Present to Staff recommendations pertaining to the sale of existing partnership funds on the secondary market exceeding \$50 million in Fair Market Value. Such transactions shall be brought to the Board for review and approval. • Provide investment analysis reports for each new investment and for sales of partnership fund interest on the secondary market or to other limited partner(s) or potential buyer(s). • Communicate with Staff regarding potential investment opportunities undergoing analysis and due diligence. • Coordinate meetings with general partners at the request of Staff. • Advise on and negotiate investment terms.